FIRE, An Opportunity to Explore and Understand Burning Plasma Science

**Dale M. Meade
for the FIRE Team**

**Presented at
43rd Annual Meeting of the APS-DPP
Long Beach, CA**

November 1, 2001

<http://fire.pppl.gov>

FIRE

Lighting the Way to Fusion

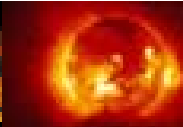

Outline

- **Objectives for a Next Step Experiment in Magnetic Fusion**
- **Burning Plasma Performance Considerations**
- **Compact High Field Approach - General Parameters**
- **Advanced Tokamak Longer Pulse Possibilities**
- **Summary**

A Window of Opportunity for Energy R&D

- Increased awareness on the importance of a secure energy supply
 - National Policy Report -The NEPD Group recommends that the President direct the Secretary of Energy to develop next-generation technology—including hydrogen and fusion.
 - HR-4 - to provide for security and diversity in the energy supply
- Link between economic growth and stable/affordable energy
- Global Climate Change and pressure from other nations for U. S. participation in CO₂ emission reduction.
- Energy Independence is becoming an issue for the U.S.

Need to be ready when the window opens

Panel Recommendation Fully Endorsed by FESAC August 2, 2001

3. *The US Fusion Energy Sciences Program should establish a proactive US plan on burning plasma experiments and should not assume a default position of waiting to see what the international community may or may not do regarding the construction of a burning plasma experiment. If the opportunity for international collaboration occurs, the US should be ready to act and take advantage of it, but should not be dependent upon it. The US should implement a plan as follows to proceed towards construction of a burning plasma experiment:*

- Hold a “Snowmass” workshop in the summer, 2002 for the critical scientific and technological examination of proposed burning plasma experimental designs and to provide crucial community input and endorsement to the planning activities undertaken by FESAC. Specifically, the workshop should determine which of the specific burning plasma options are technically viable, but should not select among them. The workshop would further confirm that a critical mass of fusion scientists believe that *the time to proceed is now* and not some undefined time in the future.
- Carry out a uniform technical assessment led by the NSO program of each of the burning plasma experimental options for input into the Snowmass summer study.
- Request the Director of the Office of Energy Sciences to charge FESAC with the mission of forming an “action” panel in Spring, 2002 to select among the technically viable burning plasma experimental options. The selected option should be communicated to the Director of the Office of Science by January, 2003.
- Initiate a review by a National Research Council panel in Spring, 2002, with the goal of determining the desirability as well as the scientific and technological credibility of the burning plasma experiment design by Fall, 2003. This is consistent with a submission of a report by DOE to congress no later than July, 2004.
- Initiate an outreach effort coordinated by FESAC (or an ad-hoc body) to establish an appreciation and support for a burning plasma experiment from science and energy policy makers, the broader scientific community, environmentalists and the general public. This effort should begin now.

One Step to DEMO ^{1, 2}

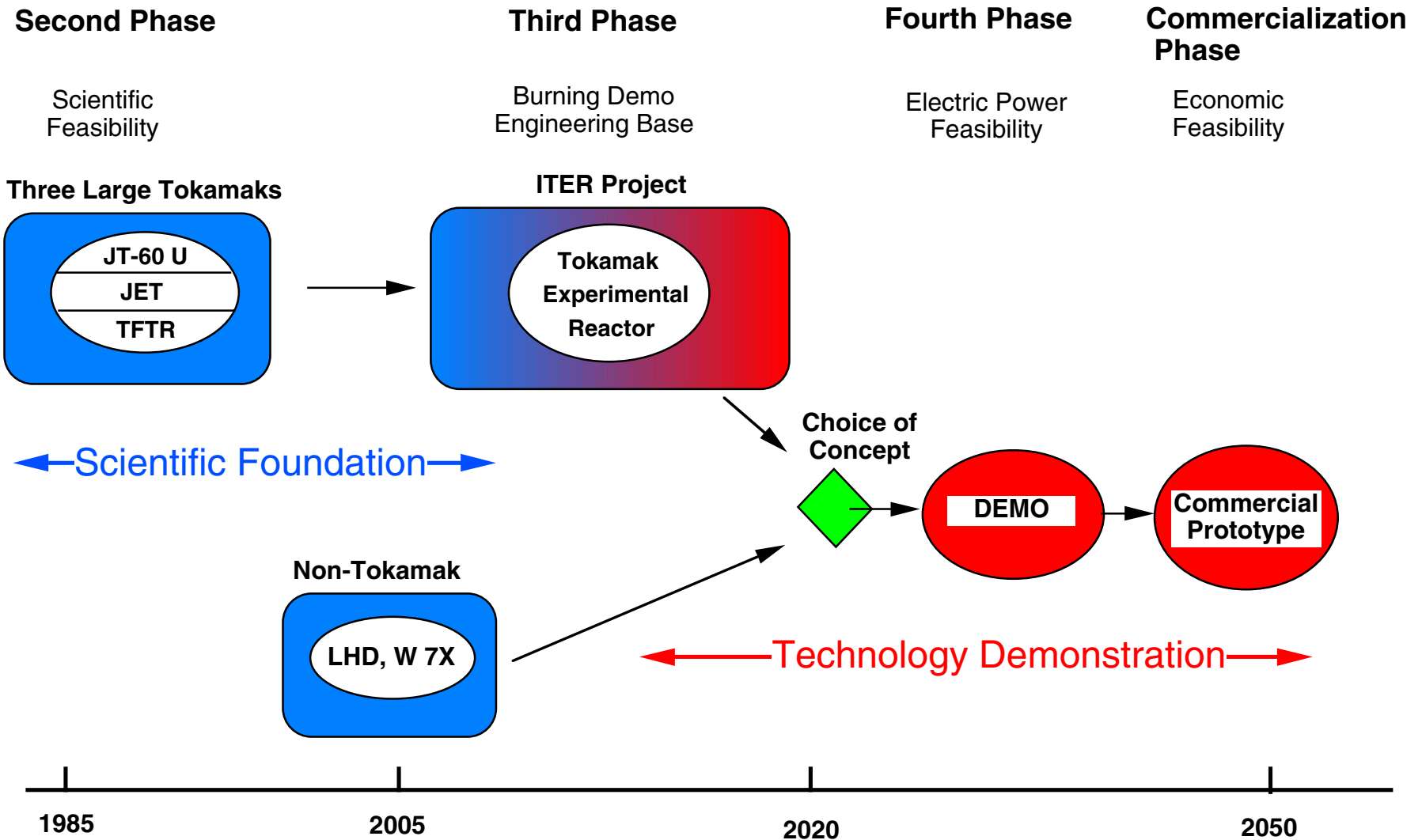

1. Technical Feasibility of Fusion Energy, SubCom of (Japan) Fusion Council for Fusion Development Strategy, May 2000

2. European Plan Airaghi Report, May 2000

Critical Issues to be Addressed in the Next Stage of Fusion Research

- **Burning Plasma Physics**
 - strong nonlinear coupling inherent in a fusion dominated plasma
 - access, explore and understand fusion dominated plasmas
- **Advanced Toroidal Physics**
 - develop and test physics needed for an attractive MFE reactor
 - couple with burning plasma physics
- **Boundary Physics and Plasma Technology** (coupled with above)
 - high particle and heat flux
 - couple core and divertor
 - fusion plasma - tritium inventory and helium pumping
- **Neutron Resistant Materials** (separate facility)
 - high fluence testing using “point”neutron source

-
- Superconducting Coil Technology does not have to be coupled to physics experiments - only if needed for physics objectives
 - Nuclear Component Testing should wait for reactor materials

The Modular Strategy for MFE

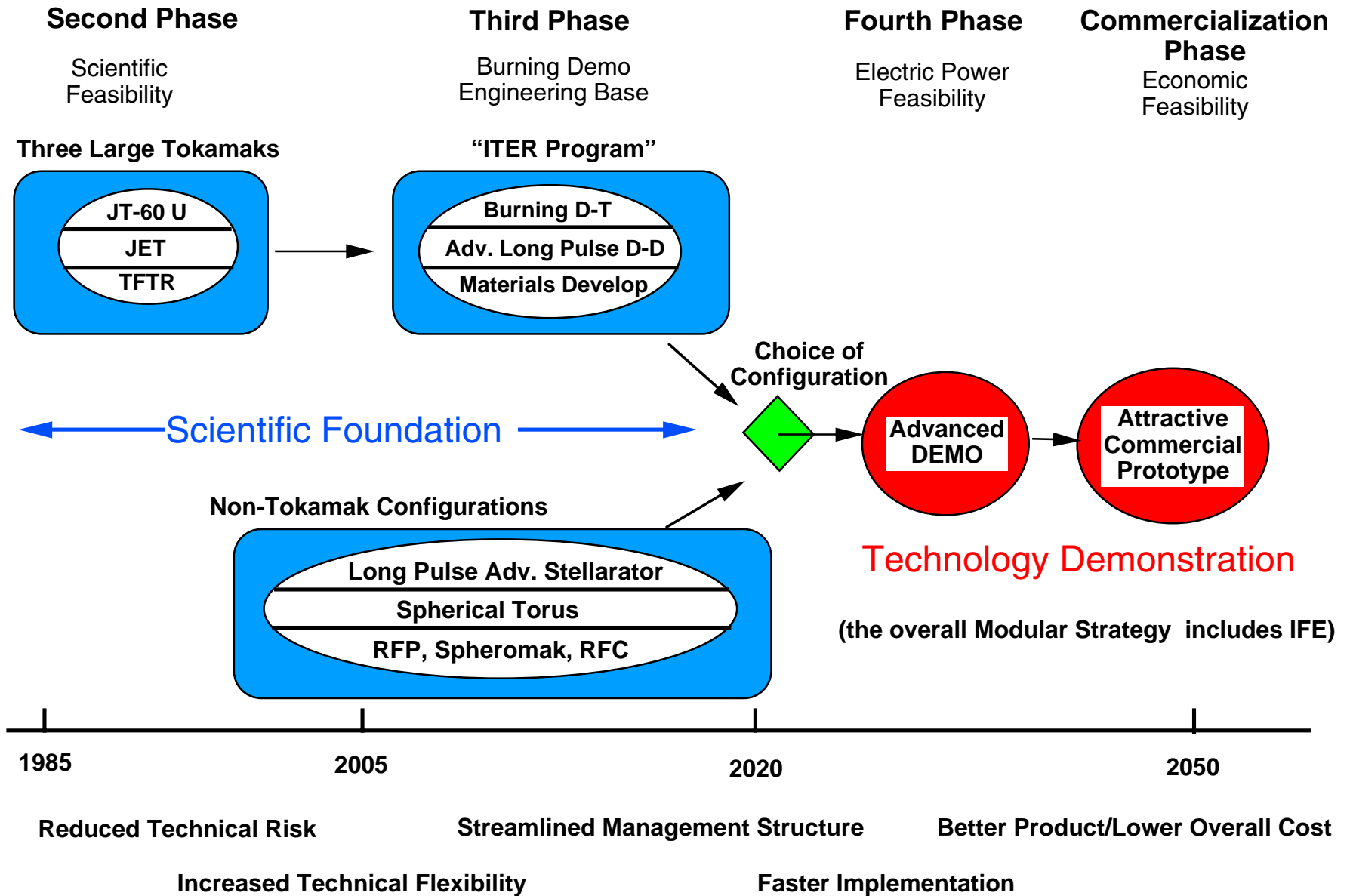

Next Step Option Program Advisory Committee

- **Members:** Tony Taylor (Chair), Gerald Navratil, Ray Fonck, David Gates, Dave Hill, Wayne Houlberg, Tom Jarboe, Mitsuro Kikuchi, Earl Marmor, Raffi Nazikian, Craig Petty, Rene Raffray, Paul Thomas, James VanDam
- **Meetings**
 - July 20-21, 2000 at General Atomics, San Diego, CA.
 - January 17-18, 2001 at MIT, Cambridge, MA
 - July 10-11, 2001 at Univ. Wisc, Madison, WI
- **Charge for First and Second meetings**
 - Scientific value of a Burning Plasma experiment
 - Scientific readiness to proceed with such an experiment
 - Is the FIRE mission scientifically appropriate?
 - Is the initial FIRE design point optimal?
- Extensive PAC Reports provide detailed recommendations for the FIRE activity to address. NSO-PAC reports are on FIRE (<http://fire.pppl.gov>), will discuss in more detail under FY 2001-03 Plans.

Fusion Plasmas are Complex Non-Linear Dynamic Systems

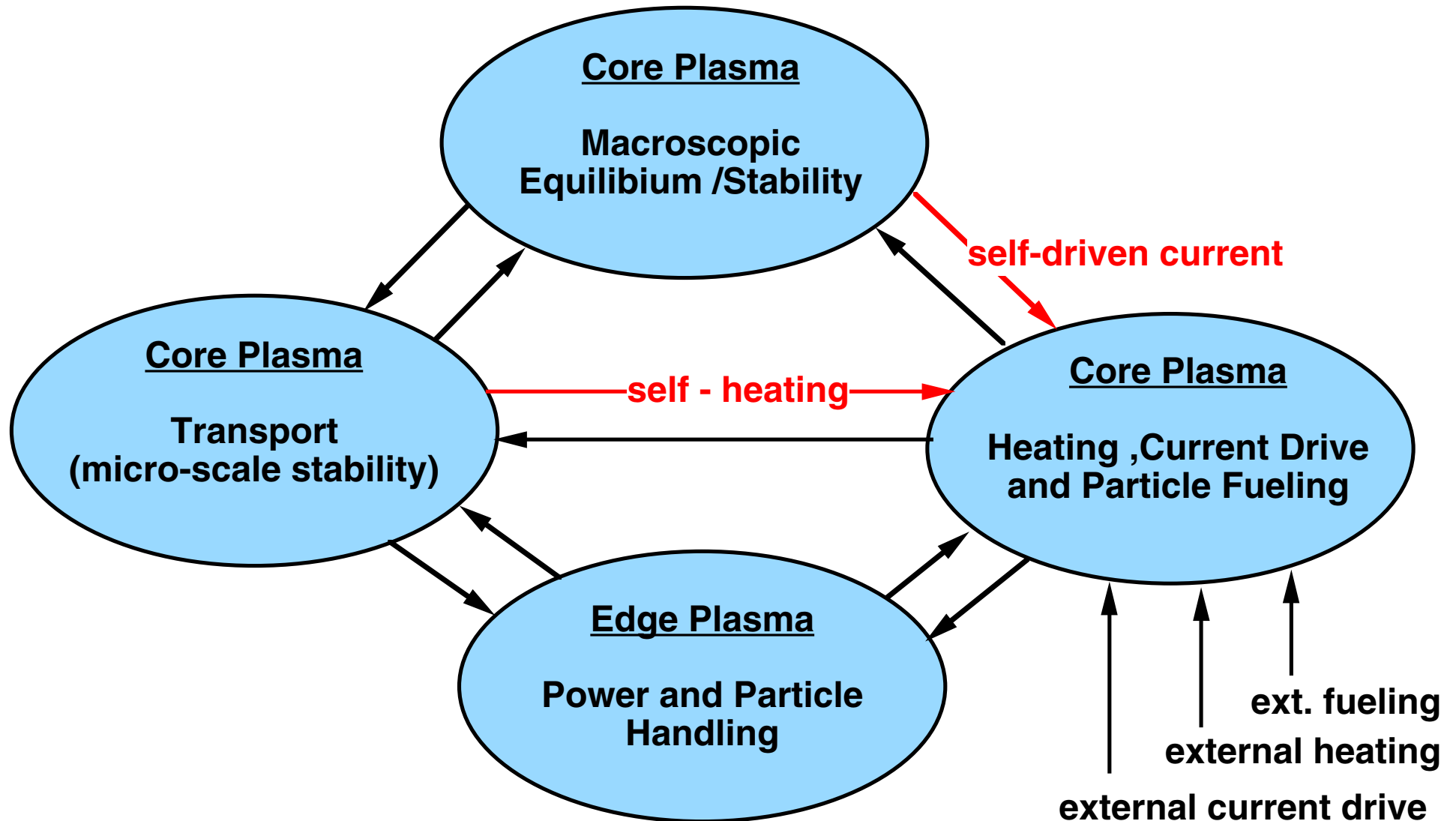

Under what conditions do stable solutions exist?

Fusion Science Objectives for a Major Next Step Burning Plasma Experiment

Explore and understand the strong non-linear coupling that is fundamental to fusion-dominated plasma behavior (self-organization)

- Energy and particle transport (extend confinement predictability)
 - Macroscopic stability (β -limit, wall stabilization, NTMs)
 - Wave-particle interactions (fast alpha particle driven effects)
 - Plasma boundary (density limit, power and particle flow)
- Test/Develop techniques to control and optimize fusion-dominated plasmas.
 - Sustain fusion-dominated plasmas - high-power-density exhaust of plasma particles and energy, alpha ash exhaust, study effects of profile evolution due to alpha heating on macro stability, transport barriers and energetic particle modes.
 - Explore and understand various advanced operating modes and configurations in fusion-dominated plasmas to provide generic knowledge for fusion and non-fusion plasma science, and to provide a foundation for attractive fusion applications.

Advanced Burning Plasma Exp't Requirements

Burning Plasma Physics

$Q \geq 5$, ~ 10 as target, ignition not precluded

$f_\alpha = P_\alpha/P_{\text{heat}} \geq 50\%$, $\sim 66\%$ as target, up to 83% at $Q = 25$

TAE/EPM stable at nominal point, able to access unstable

Advanced Toroidal Physics

$f_{\text{bs}} = I_{\text{bs}}/I_p \geq 50\%$ up to 75%

$\beta_N \sim 2.5$, no wall ~ 3.6 , $n = 1$ wall stabilized

Quasi-stationary

Pressure profile evolution and burn control $> 10 \tau_E$

Alpha ash accumulation/pumping $> \text{several } \tau_{\text{He}}$

Plasma current profile evolution 1 to 3 τ_{skin}

Divertor pumping and heat removal several $\tau_{\text{divertor}}, \tau_{\text{first wall}}$

Optimization of a Burning Plasma Experiment

- Consider an inductively driven tokamak with copper alloy TF and PF coils precooled to LN temperature that warm up adiabatically during the pulse.
- Seek minimum R while varying A and space allocation for TF/PF coils for a specified plasma performance - Q and pulse length with physics and eng. limits.

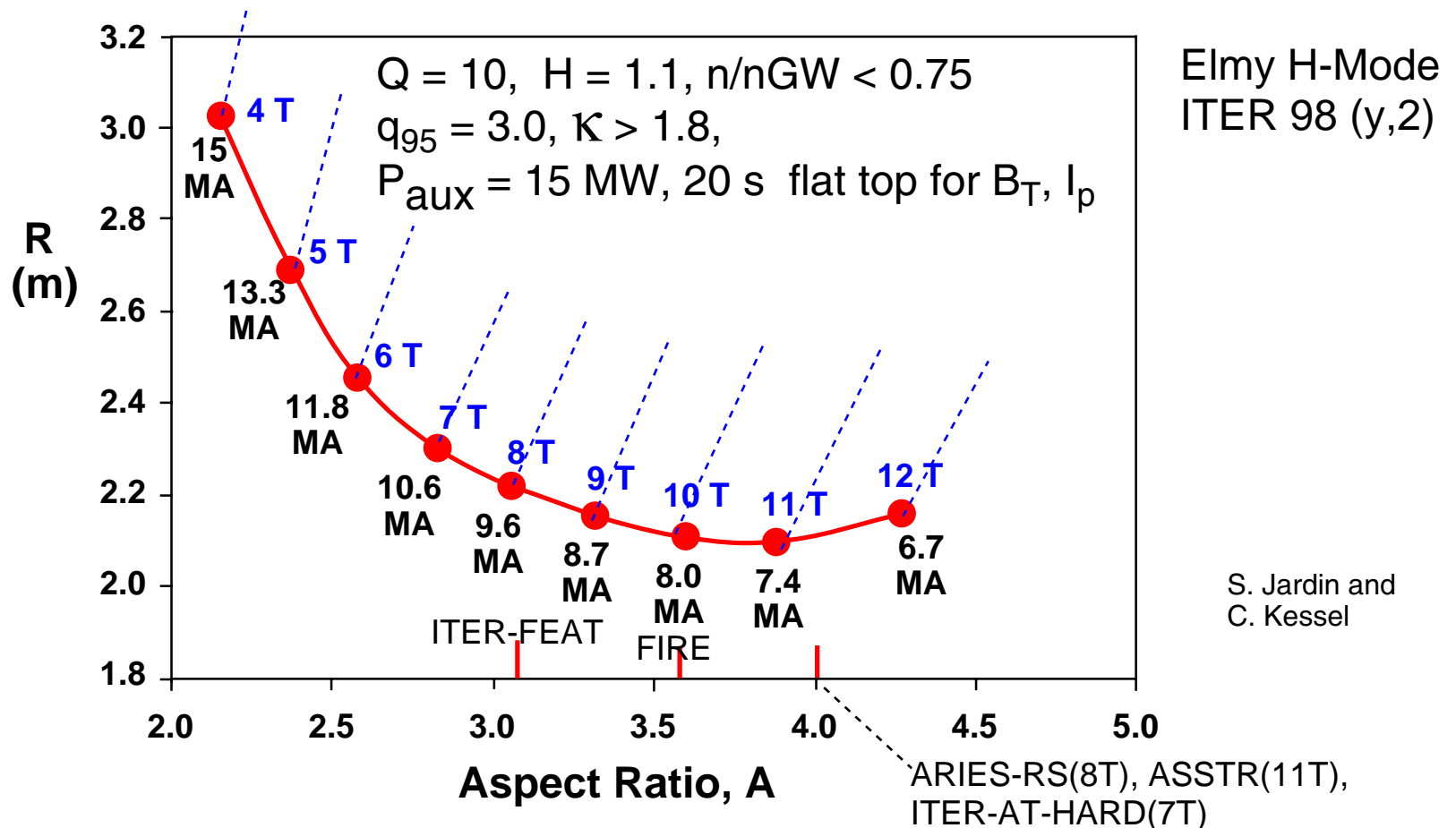

What is the optimum for ITBs or AT modes?

Fusion Ignition Research Experiment

(FIRE)

<http://fire.pppl.gov>

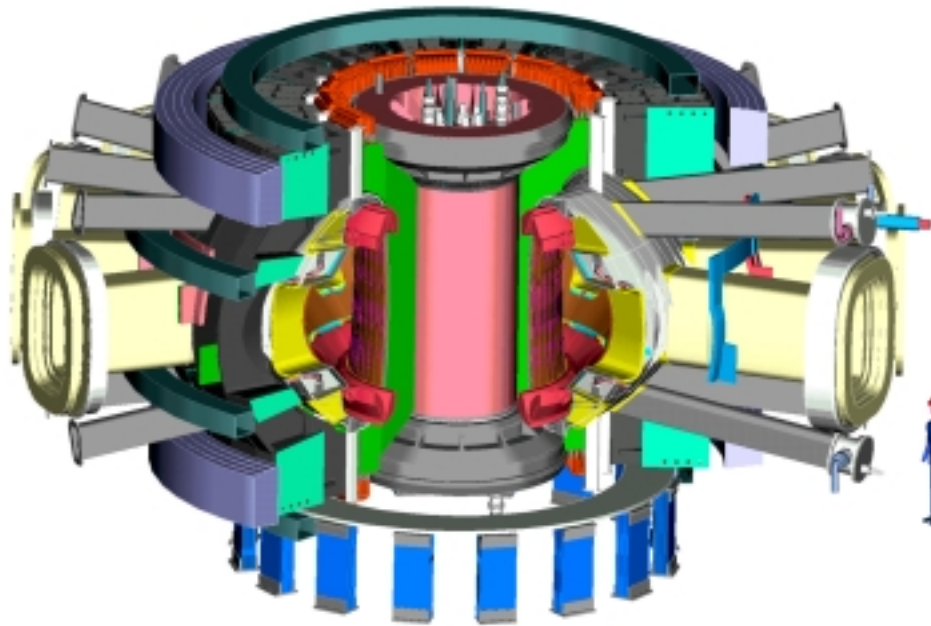

Design Features

- $R = 2.14 \text{ m}$, $a = 0.595 \text{ m}$
- $B = 10 \text{ T}$
- $W_{\text{mag}} = 5.2 \text{ GJ}$
- $I_p = 7.7 \text{ MA}$
- $P_{\text{aux}} \leq 20 \text{ MW}$
- $Q \approx 10$, $P_{\text{fusion}} \sim 150 \text{ MW}$
- Burn Time $\approx 20 \text{ s}$
- Tokamak Cost $\approx \$375\text{M}$ (FY99)
- Total Project Cost $\approx \$1.2\text{B}$ at Green Field site.

Mission:

Attain, explore, understand and optimize fusion-dominated plasmas.

FIRE is a “Modest” Extrapolation in Plasma Confinement

Dimensionless Parameters
$\omega_c \tau$
$\rho^* = \rho/a$
$v^* = v_c/v_b$
β

Similarity Parameter
$B R^{5/4}$

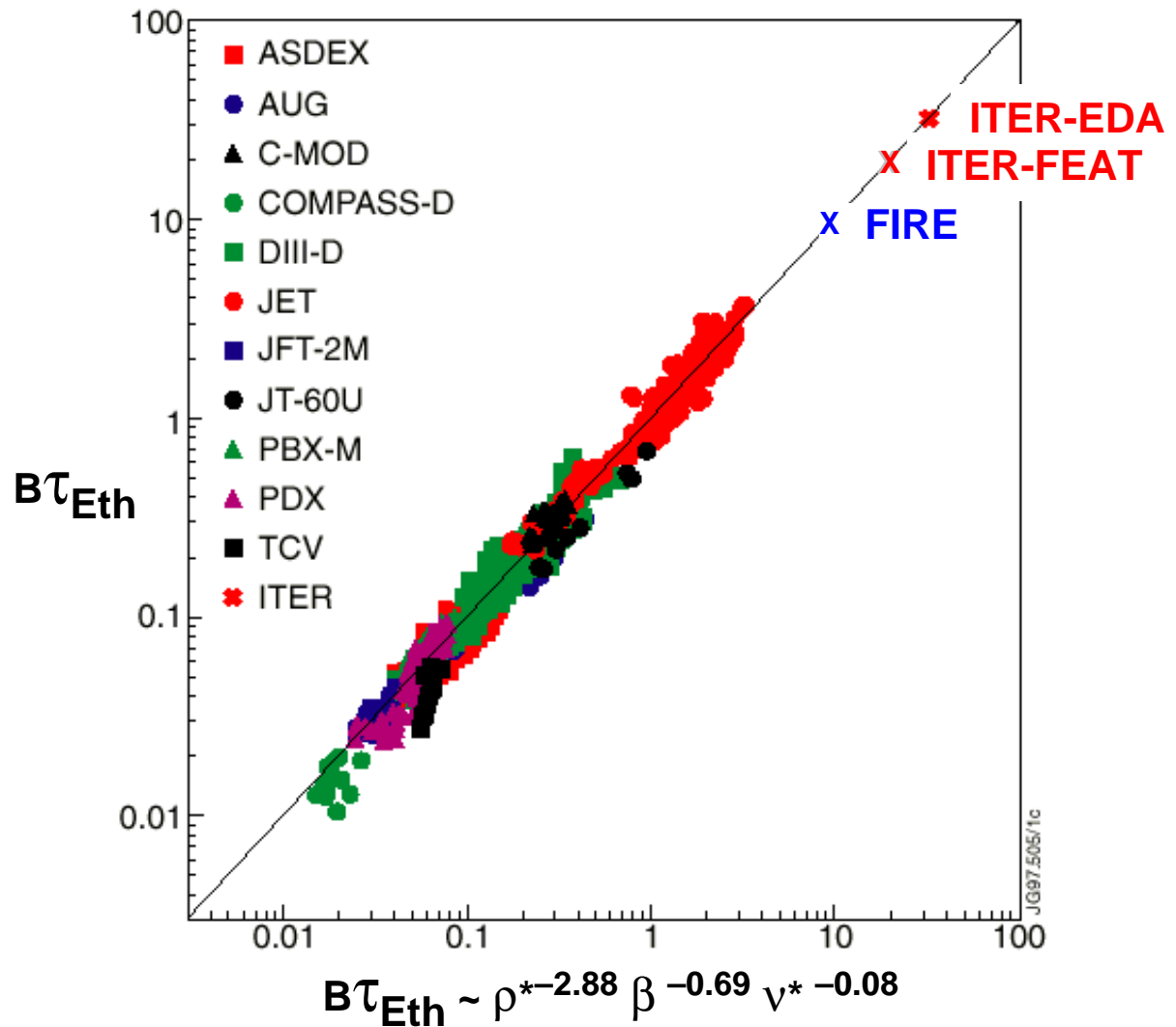

Kadomtsev, 1975

Parameters for H-Modes in Potential Next Step D-T Plasmas

ITER-FEAT (15 MA): $Q = 10$, $H = 0.95$, FIRE*(7.7 MA): $Q = 10$, $H = 1.03$, JET-U (6 MA): $Q = 0.64$, $H = 1.1$

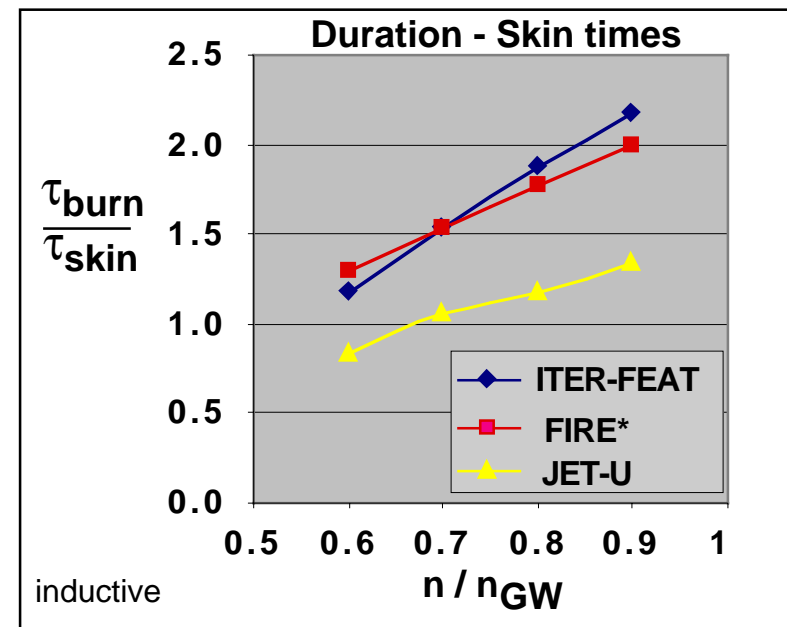
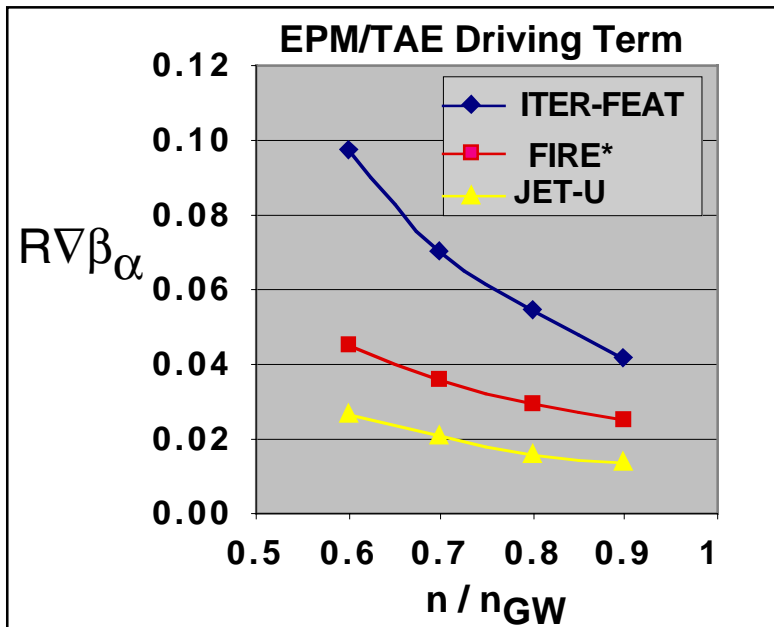
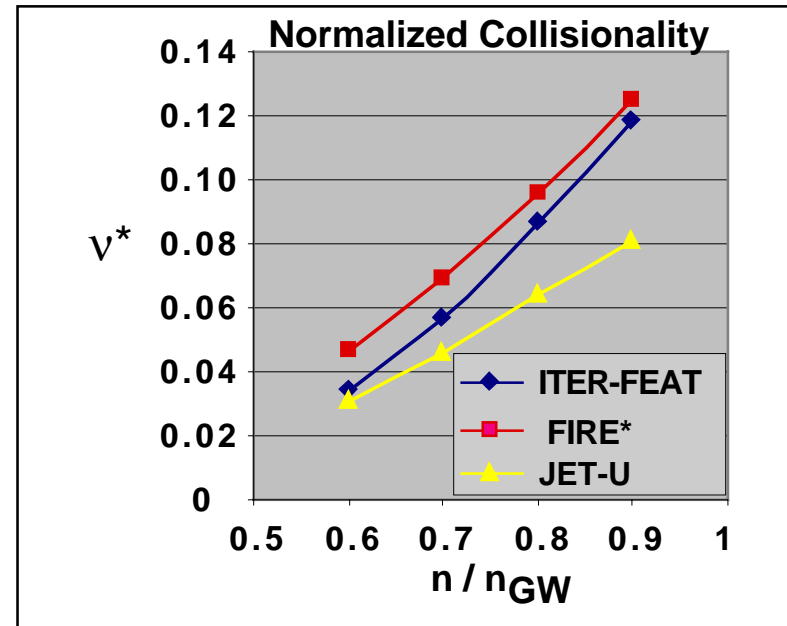
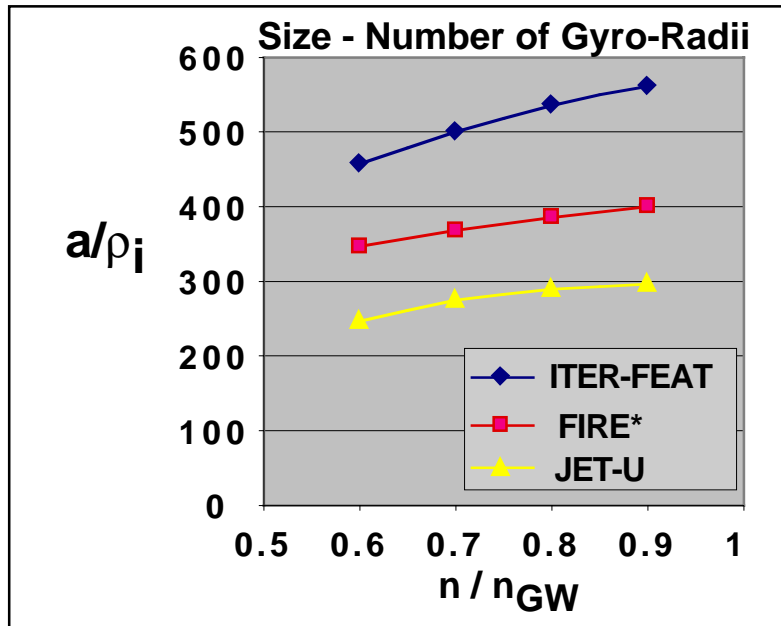

Guidelines for Estimating Plasma Performance

Confinement (Elmy H-mode) - ITER98(y,2) based on today's data base

$$\tau_E = 0.144 I^{0.93} R^{1.39} a^{0.58} n_{20}^{0.41} B^{0.15} A_i^{0.19} \kappa^{0.78} P_{\text{heat}}^{-0.69} H(y,2)$$

Density Limit - Based on today's tokamak data base

$$n_{20} \leq 0.8 n_{\text{GW}} = 0.8 I_p / \pi a^2,$$

Beta Limit - theory and tokamak data base

$$\beta \leq \beta_N(I_p/aB), \quad \beta_N < 2.5 \text{ conventional}, \quad \beta_N \sim 4 \text{ advanced}$$

H-Mode Power Threshold - Based on today's tokamak data base

$$P_{\text{th}} \geq (2.84/A_i) n_{20}^{0.58} B^{0.82} Ra^{0.81}, \quad \text{same as ITER-FEAT}$$

Helium Ash Confinement $\tau_{\text{He}} = 5 \tau_E$, impurities = 3% Be, 0% W

Understanding is mainly empirical. Better understanding is needed from existing experiments with improved simulations, and a benchmark in alpha-dominated fusion plasmas is needed to confirm and extend the science basis.

Comparison Operating Ranges of ITER-EDA, ITER-FEAT and FIRE with JET H-Mode Data

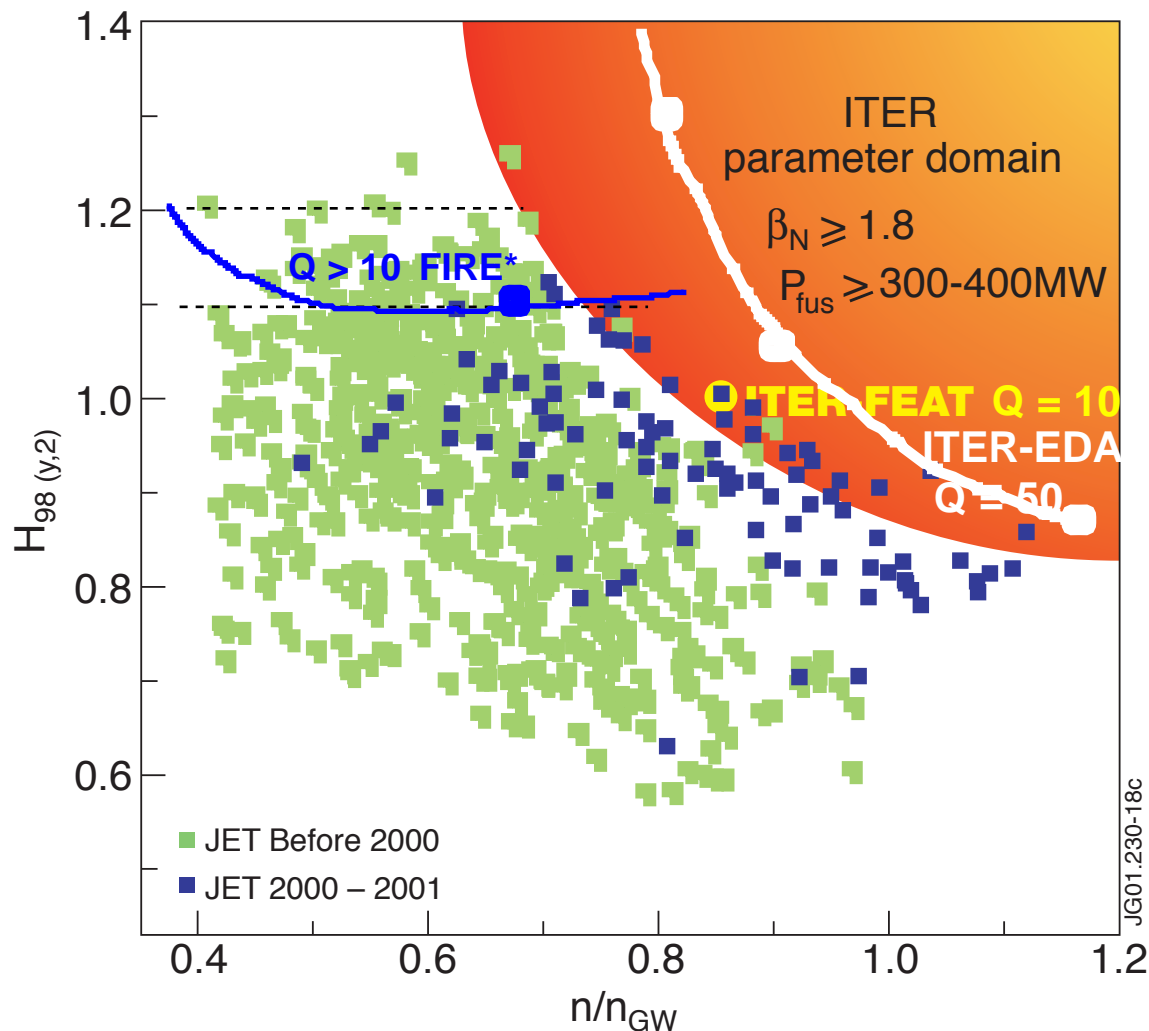

- Extension of JET parameter domain leading to simultaneous realization of $H_{98(y,2)} = 1$, $n/n_{GW} > 0.9$ and $\beta_N \geq 1.8$ using different approaches and
- In addition Plasma purity as required for ITER: $Z_{eff} \sim 1.5$
- For quasi-stationary phases of several seconds
- **Consolidation of ITER Q = 10 Reference scenario**
- **FIRE and ITER exploit different parts of the data base. Note added - DMM**

GLF23 Transport Model With Real Geometry ExB Shear Shows Improved Agreement With L- and H-mode and ITB Profile Database

Statistics computed incremental stored energy (subtracting pedestal region) using exactly same model used for ITB simulations

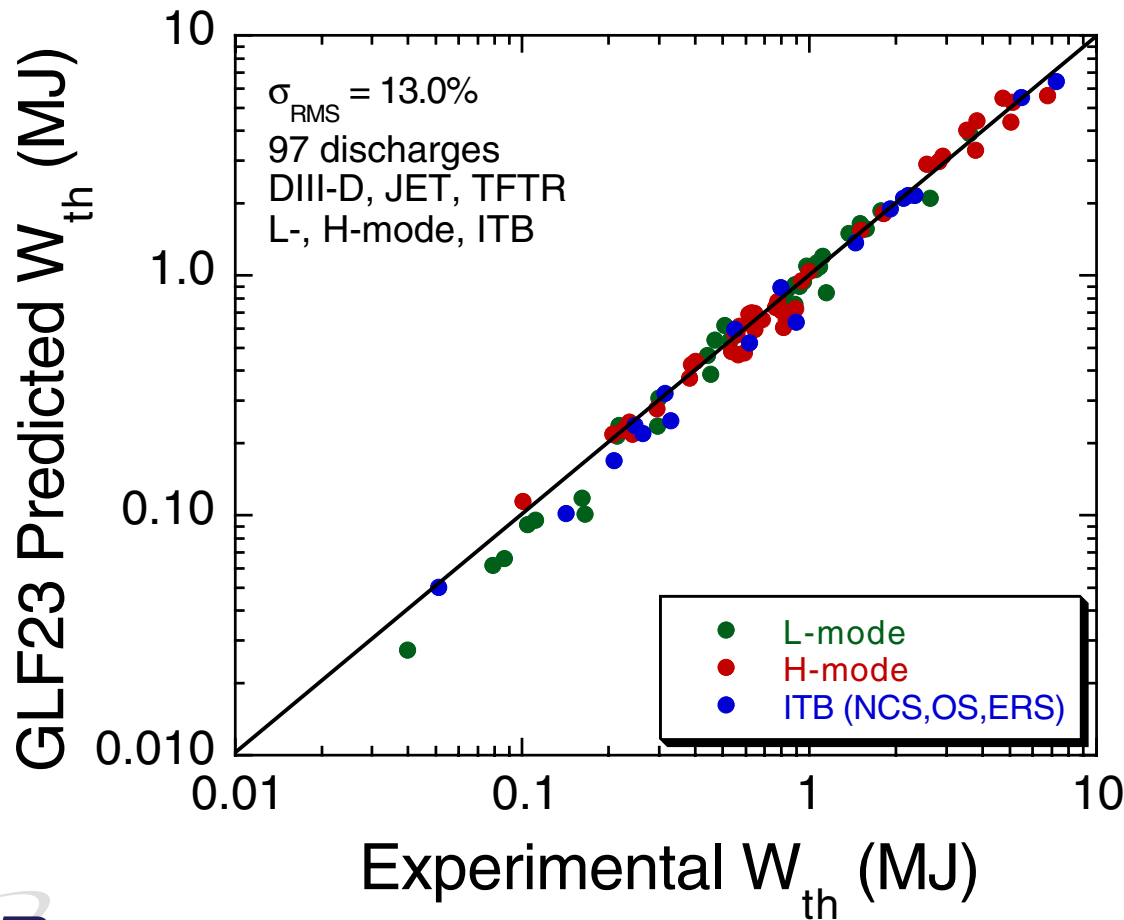

* T_e, T_i, v_ϕ
predicted for ITBs

Pedestal Temperature Requirements for Q=10

Device	Flat ne [◆]	Peaked ne [*]	Peaked ne w/ reversed q
IGNITOR[◆]	5.1	5.0	5.1
FIRE	4.1	4.0	3.4
ITER-FEAT[✦]	5.8	5.6	5.4

- ◆ flat density cases have monotonic safety factor profile
- * $n_{eo} / n_{ped} = 1.5$ with n_{ped} held fixed from flat density case
- ◆ 10 MW auxiliary heating
 - 11.4 MW auxiliary heating
- ✦ 50 MW auxiliary heating

GLF23 Predicts an Internal Transport Barrier in FIRE as a Result of Shafranov-Shift Stabilization of the ITG Mode

- *Barrier only forms if some density peaking is present.*
- *Diamagnetic component of ExB shear helps after ITB is formed.*

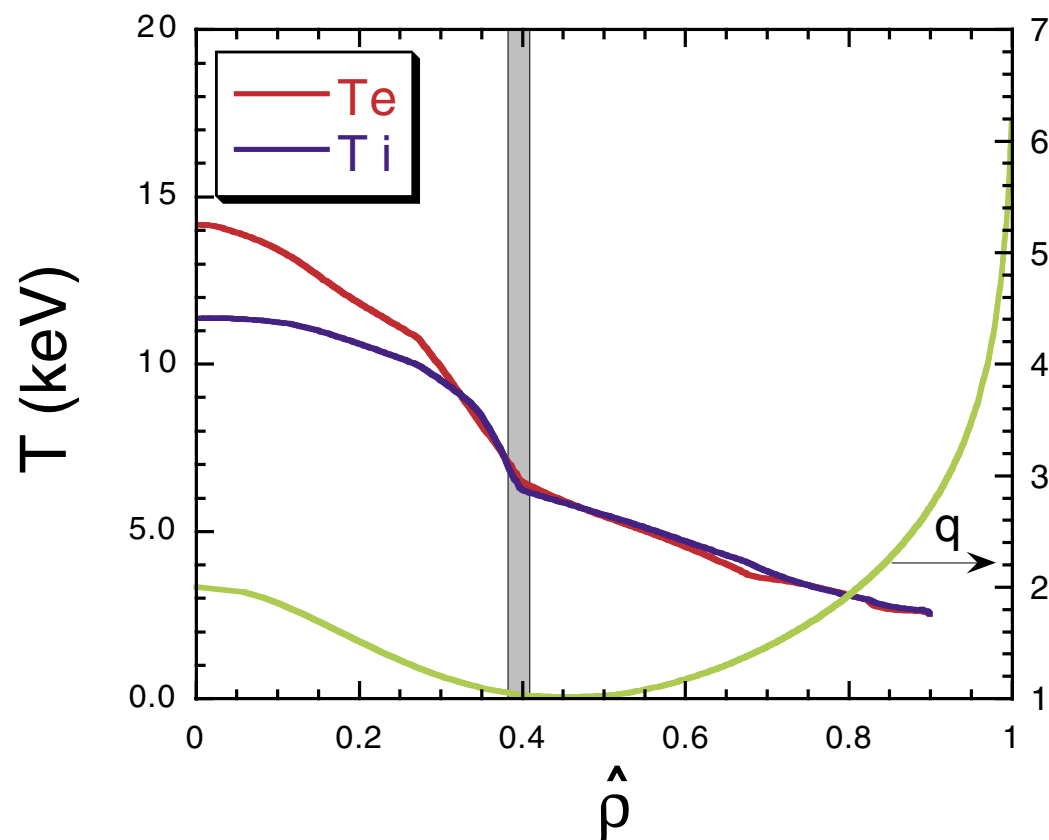

Kinsey, Waltz and Staebler
UFA BPS Workshop 2

Projections to FIRE Compared to Envisioned Reactors

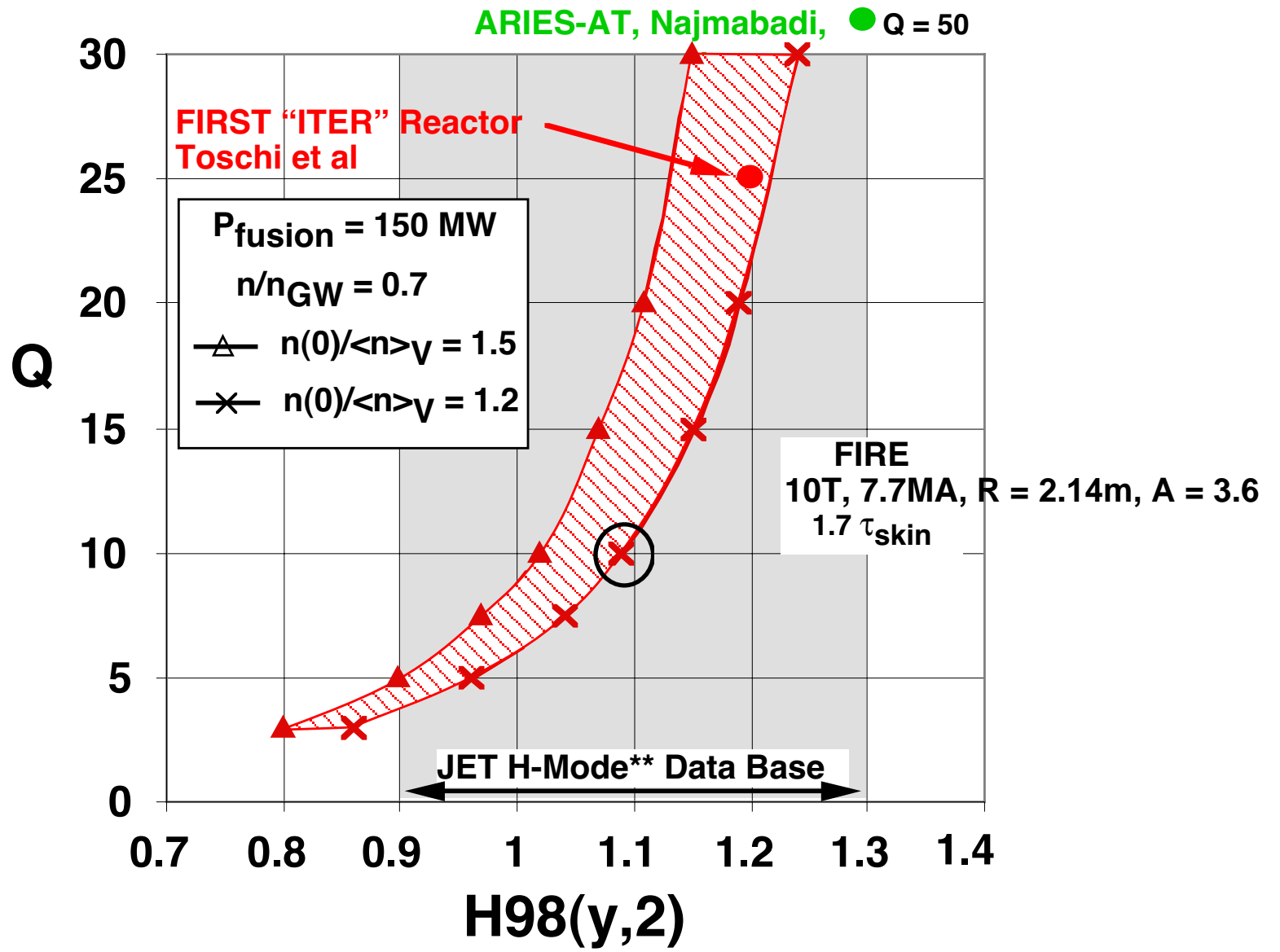

1 1/2-D Simulation of Burn Control in FIRE* (TSC)

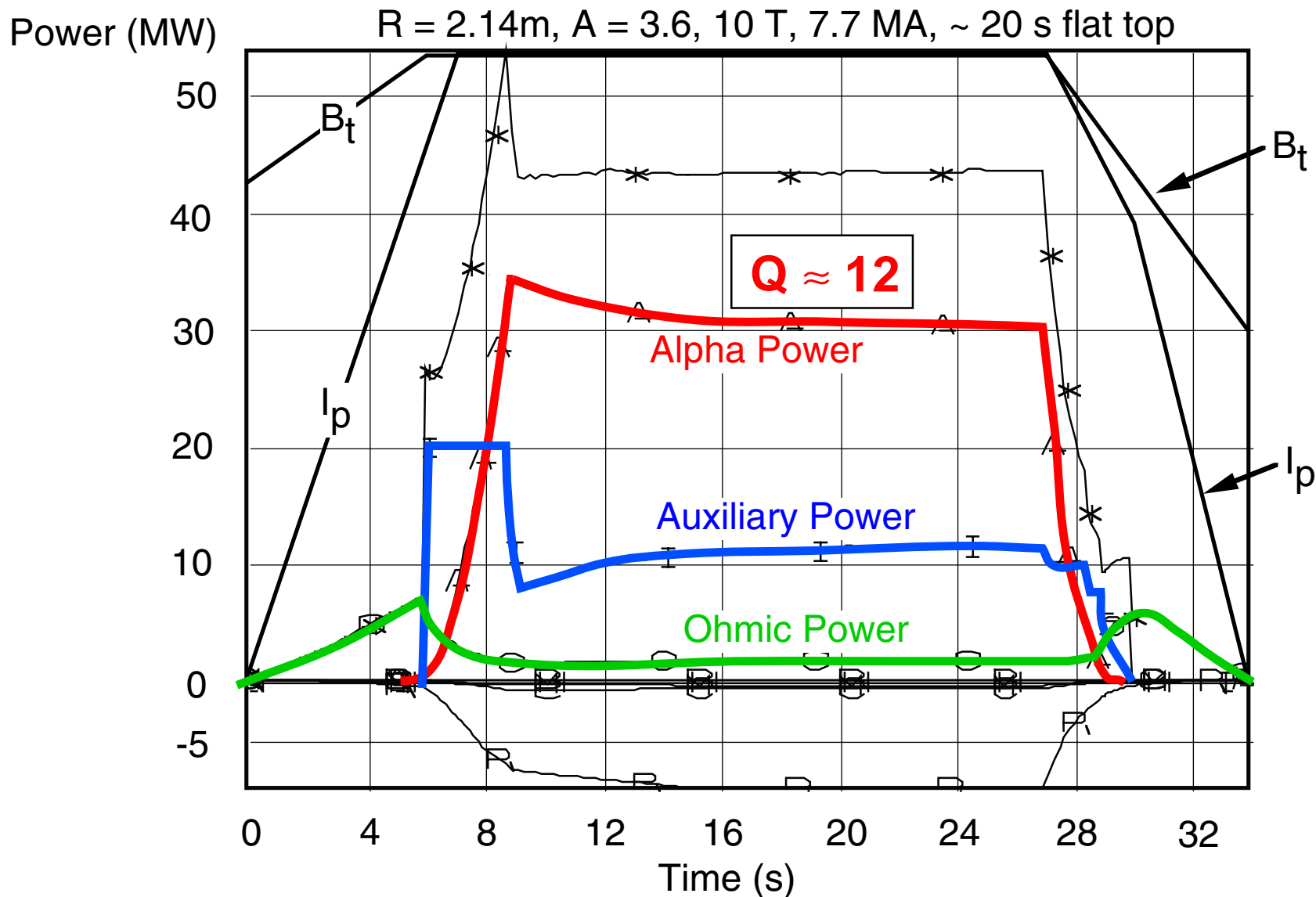

- ITER98(y,2) scaling with $H(y,2) = 1.1$, $n(0)/\langle n \rangle = 1.2$, and $n/n_{GW} = 0.67$
- Burn Time ≈ 20 s $\approx 21 \tau_E \approx 4 \tau_{He} \approx 2 \tau_{skin}$

$$Q = P_{fusion} / (P_{aux} + P_{oh})$$

Helium Ash Removal Techniques Required for a Reactor can be Studied on FIRE

Power, MW

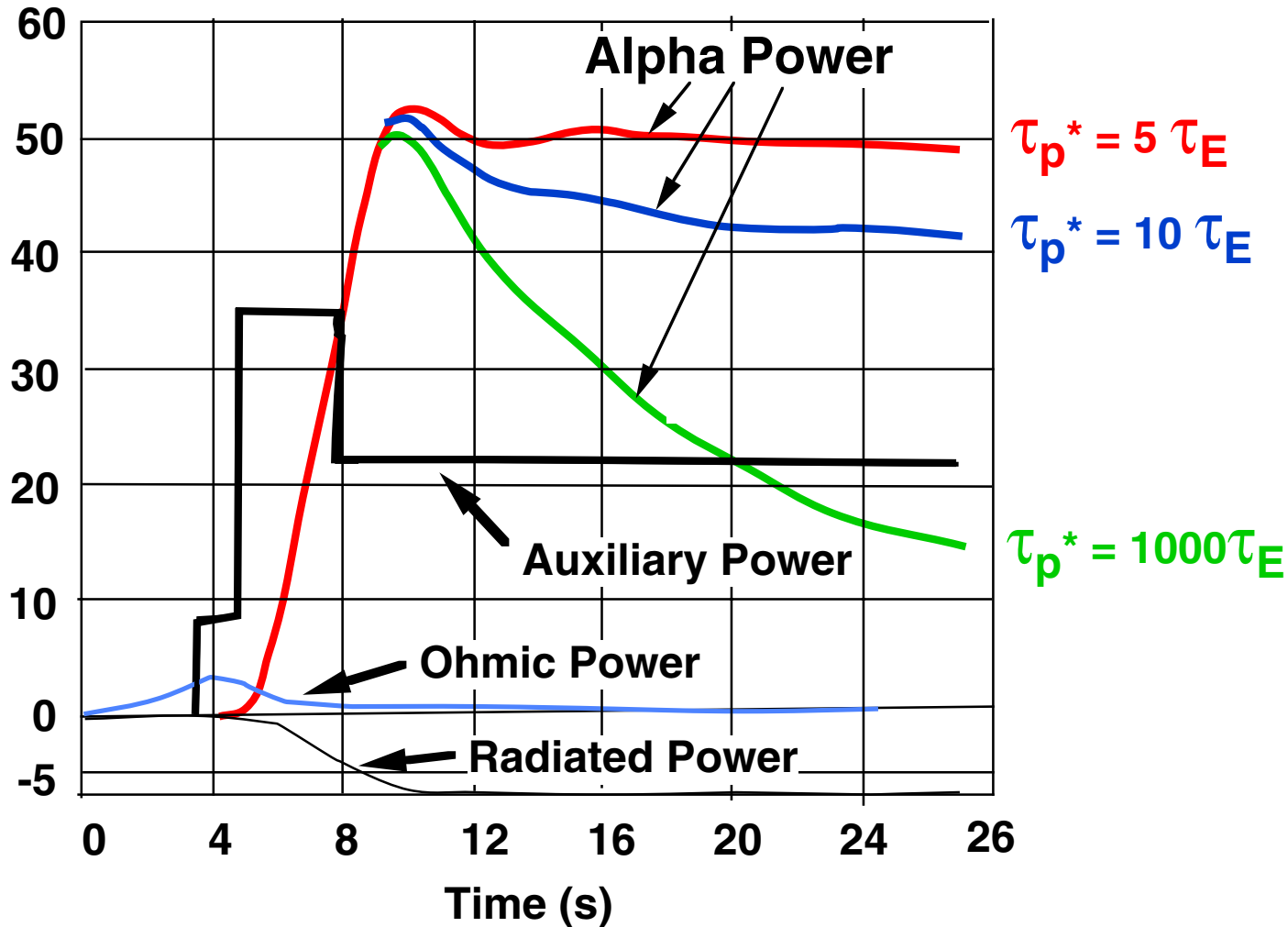

Fusion power can not be sustained without helium ash punping.

1 1/2 D Simulation of a Burning (Self-Drive > 50%) Plasma in FIRE

- $\chi(r)$ matching exp't data, $H(y, 2) = 1.6$, other models available (eg. GLF23)
- $\beta_N = 3.0$, $f_{BS} = 64\%$, reversed shear, $q_{min} \approx 2.7$ at $r/a \approx 0.8$, 3/2,5/2 NTM stable

partial wall for $n=1$

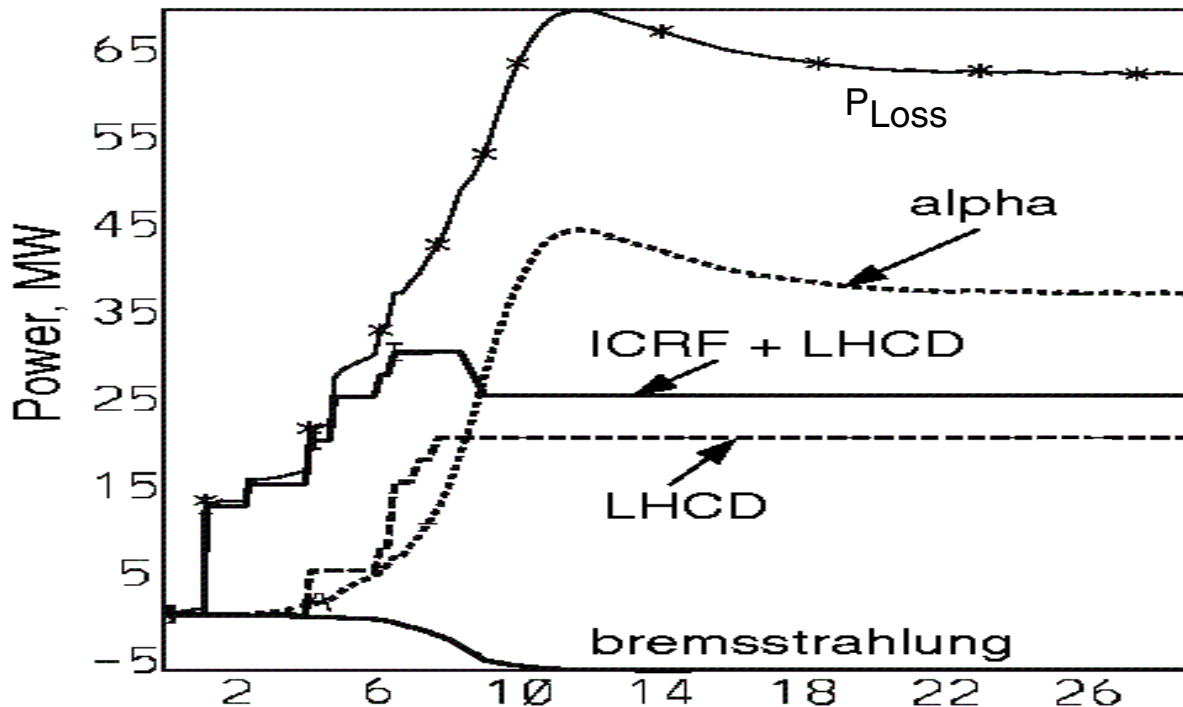

60 % self-heated

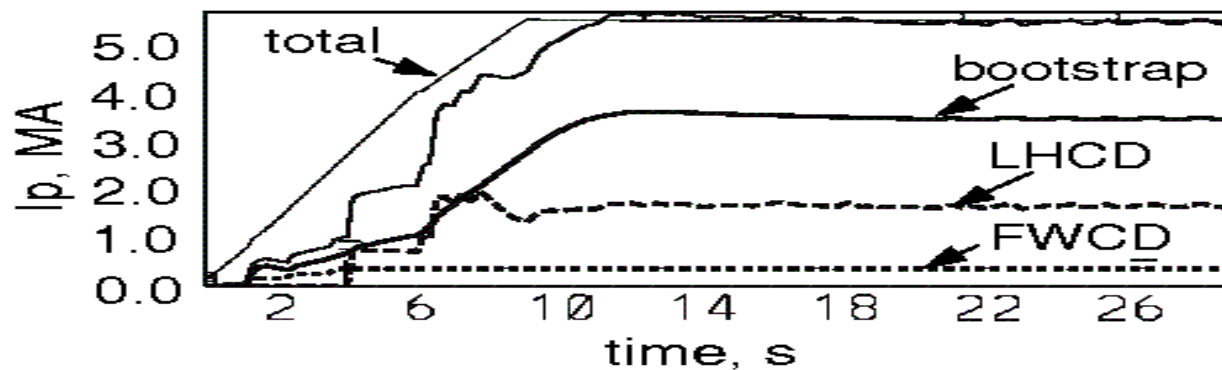

64% self-current drive

TSC -C. Kessel APS-DPP

Potential for Resistive Wall Mode Stabilization System

view of horizontal port front looking from plasma side

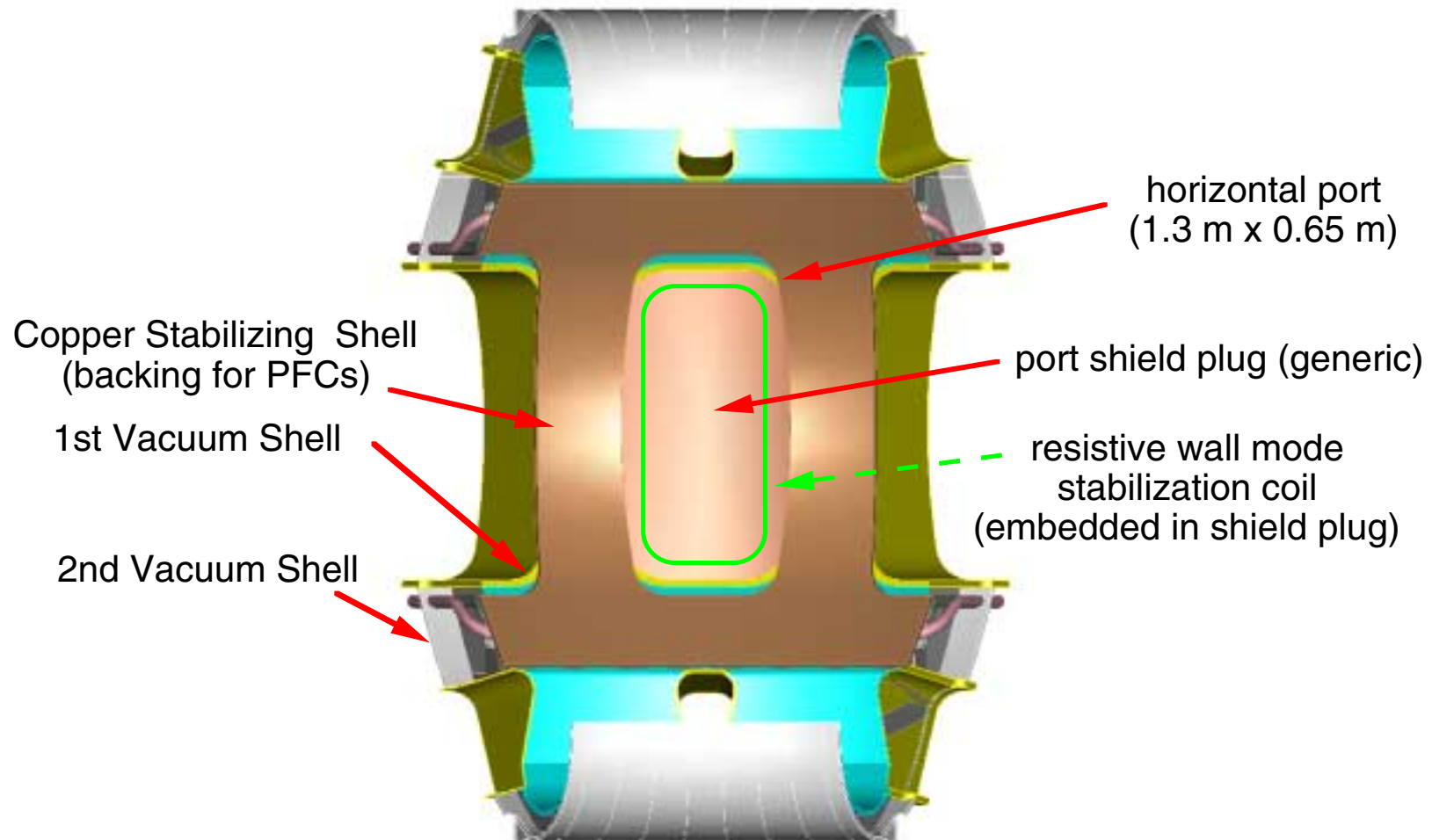

Wall stabilization required to attain full Advanced Tokamak potential.

Concept under development by Columbia Univ. J. Bialek, G. Navratil, C.Kessel(PPPL) et al

Contributors to the FIRE Engineering Design Study

FIRE is a design study for a major Next Step Option in magnetic fusion and is carried out through the Virtual Laboratory for Technology. FIRE has benefited from the prior design and R&D activities on BPX, TPX and ITER.

**Advanced Energy Systems
Argonne National Laboratory
DAD Associates
General Atomics Technology
Georgia Institute of Technology
Idaho National Engineering Laboratory
Lawrence Livermore National Laboratory
Massachusetts Institute of Technology
Oak Ridge National Laboratory
Princeton Plasma Physics Laboratory
Sandia National Laboratory
Stone and Webster
The Boeing Company
University of Illinois
University of Wisconsin**

FIRE Incorporates Advanced Tokamak Innovations

AT Features

- DN divertor
- strong shaping
- very low ripple < 0.3%
- internal coils
- space for wall stabilizers
- inside pellet injection
- large access ports

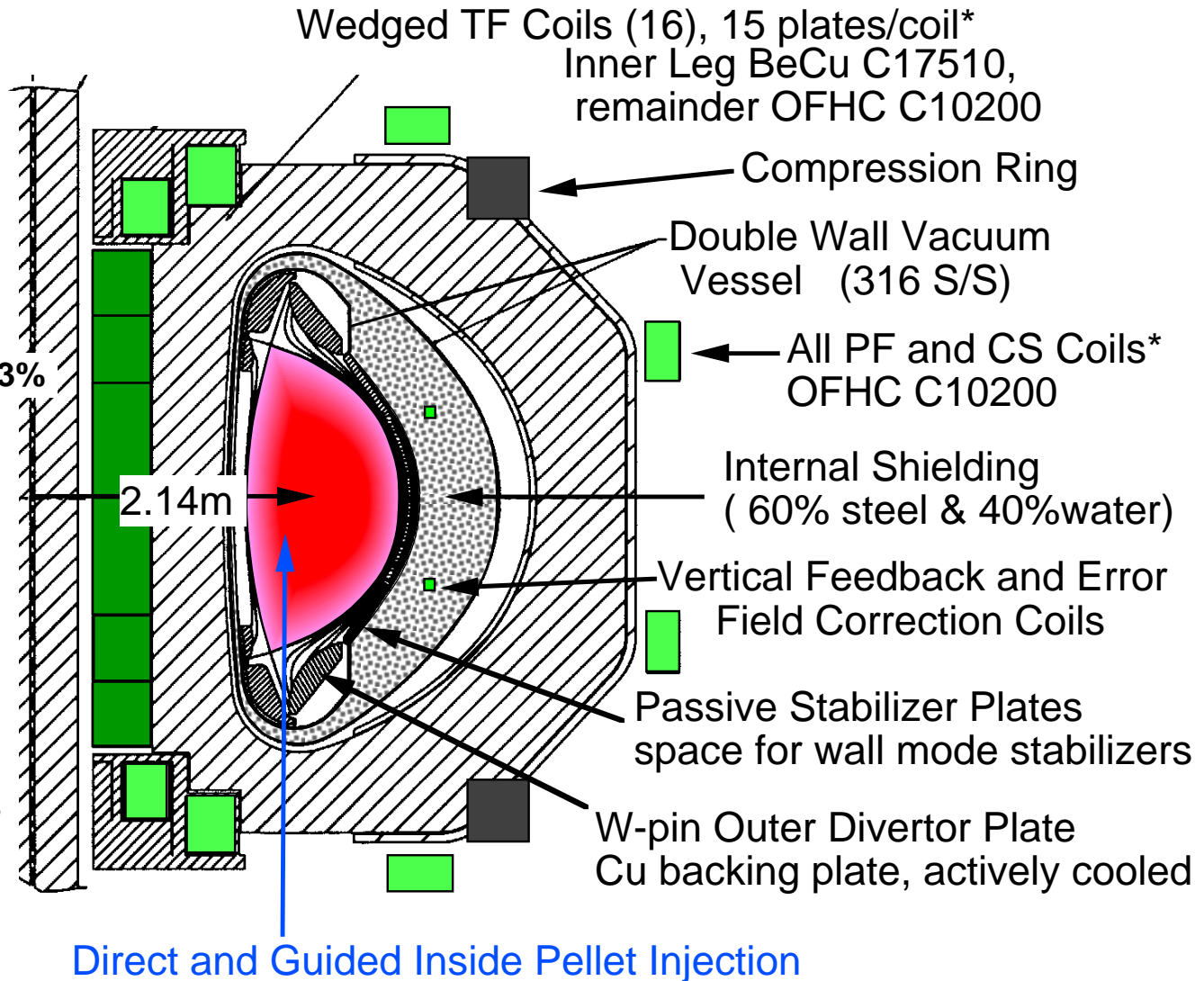

*Coil systems cooled to 77 °K prior to pulse, rising to 373 °K by end of pulse.

TF coils are being Designed with Added Margin.

- **FIRE* Baseline**
R = 2.14 m, a = 0.595 m
B = 10 T, I_p = 7.7 MA,
20 s flat top, P_{fus} = 150 MW
- **Wedged TF/compression ring**
BeCu (C17510) inner leg
- **The peak conductor VM**
Stress of 529 MPa for 10 T
(7.7 MA) is within the static
allowable stress of 724 MPa
(Allowable/Calculated = 1.3)

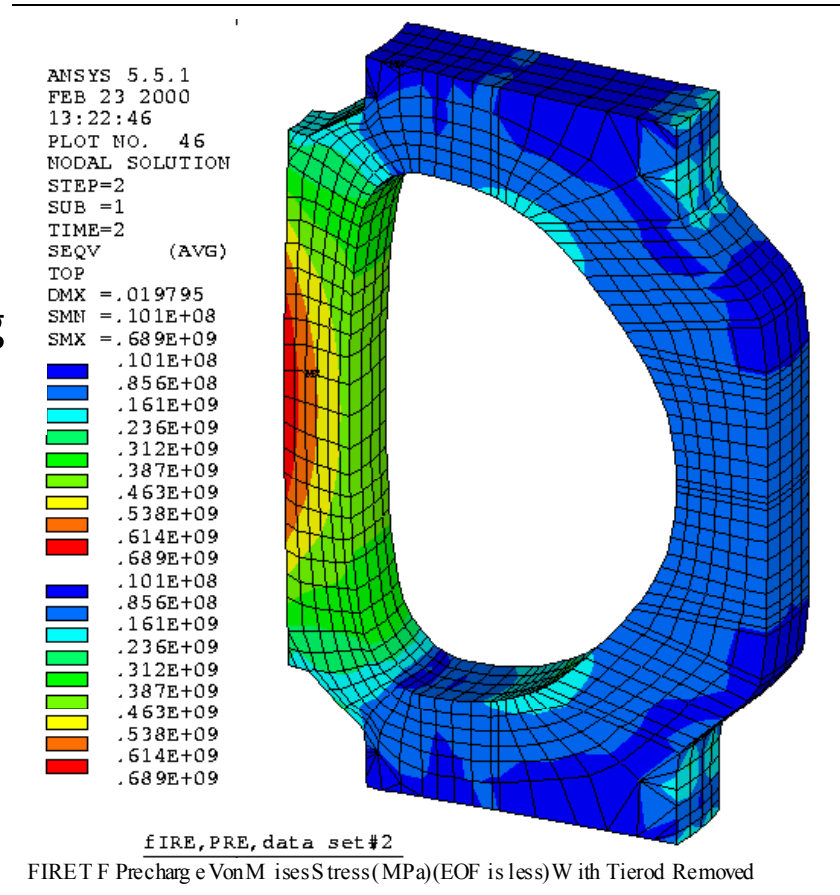

TF Coil Von Mises Stress Contours at 12 T

TF Conductor Material for FIRE is “Essentially” Available

- BeCu alloy C 17510 - 68% IACS is now a commercial product for Brush Wellman.
- A relatively small R&D program is needed to assure that the plates will be available in the properties and sizes required.

The plate on the right was manufactured for BPX

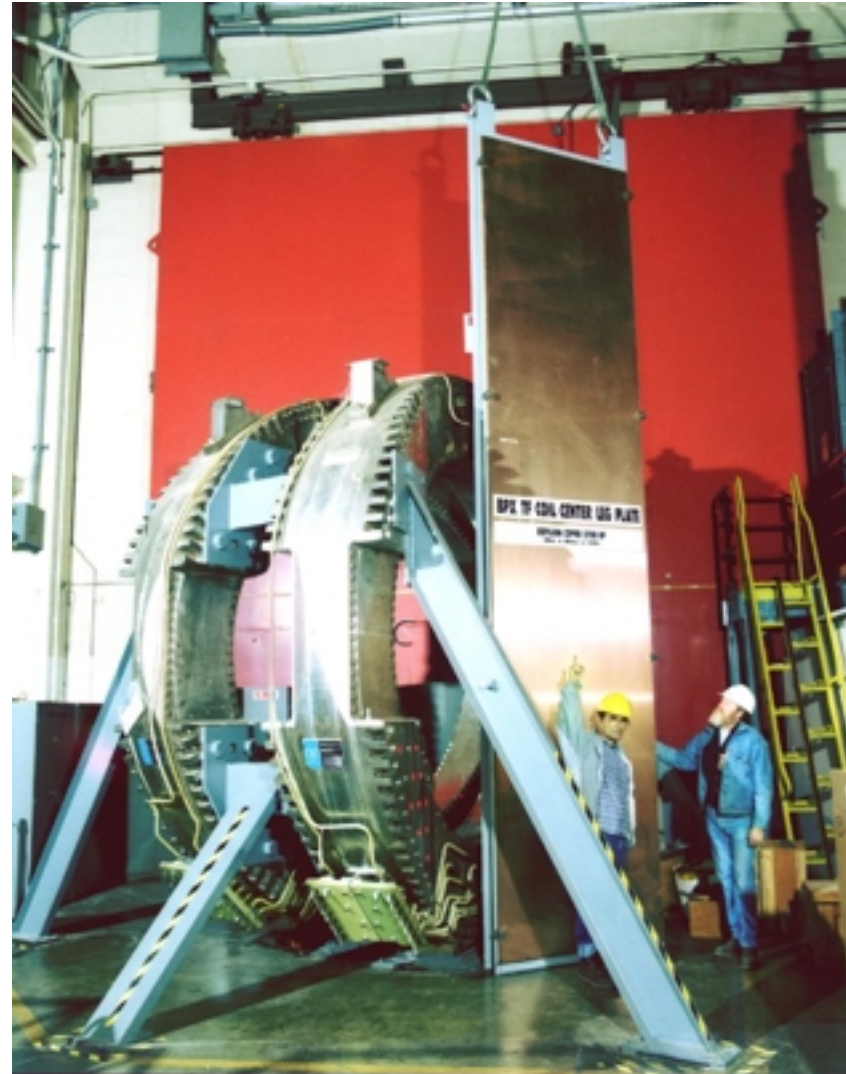

Basic Parameters and Features of FIRE

R, major radius	2.14 m
a, minor radius	0.595 m
κ_X, κ_{95}	2.0, 1.77
δ_X, δ_{95}	0.7, 0.55(AT) - 0.4(OH)
q ₉₅ , safety factor at 95% flux surface	>3
B _t , toroidal magnetic field	10 T with 16 coils, 0.3% ripple @ Outer MP
Toroidal magnet energy	5.8 GJ
I _p , plasma current	7.7 MA
Magnetic field flat top, burn time	28 s at 10 T in dd, 20s @ Pdt ~ 150 MW)
Pulse repetition time	~3hr @ full field and full pulse length
ICRF heating power, maximum	20 MW, 100MHz for 2Ω _T , 4 mid-plane ports
Neutral beam heating	Upgrade for edge rotation, CD - 120 keV PNBI?
Lower Hybrid Current Drive	Upgrade for AT-CD phase, ~20 MW, 5.6 GHz
Plasma fueling	Pellet injection (≥2.5km/s vertical launch inside mag axis, guided slower speed pellets)
First wall materials	Be tiles, no carbon
First wall cooling	Conduction cooled to water cooled Cu plates
Divertor configuration	Double null, fixed X point, detached mode
Divertor plate	W rods on Cu backing plate (ITER R&D)
Divertor plate cooling	Inner plate-conduction, outer plate/baffle- water
Fusion Power/ Fusion Power Density	150 - 200 MW, ~6 -8 MW m ⁻³ in plasma
Neutron wall loading	~ 2.3 MW m ⁻²
Lifetime Fusion Production	5 TJ (BPX had 6.5 TJ)
Total pulses at full field/power	3,000 (same as BPX), 30,000 at 2/3 B _t and I _p
Tritium site inventory	Goal < 30 g, Category 3, Low Hazard Nuclear Facility

Provisional List of Diagnostics (1)

- Magnetic Measurements
 - Rogowski Coils, Flux/voltage loops, Discrete Br, Bz coils, Saddle coils, Diamagnetic loops, Halo current sensors, Hall effect sensors
- Current Density Profiles
 - Motional Stark effect with DNB, Infrared polarimetry
- Electron Density and Temperature
 - Thomson Scattering, ECE Heterodyne Radiometer, FIR interferometer, Multichannel Interferometer, ECE Michelson interferometer, ECE Grating Polychromator, Millimeter-wave Reflectometer
- Ion Temperature
 - Charge Exchange Spectroscopy with DNB, X-Ray Crystal Spectrometer, Charge Exchange Neutral Analyzer (edge)
- Visible and Total Radiation
 - Visible Survey Spectrometer, Visible Filterscopes, Visible Bremsstrahlung Array, Bolometer Arrays, Plasma TV and Infrared TV
- Ultra Violet and X-Ray Radiation
 - UV Survey Spectrometer, Hard X-ray detectors, Soft x-ray Spectrometer, X-ray pulse height analysis



Provisional List of Diagnostics (2)

- MHD and Fluctuations
 - Mirnov Coils, Locked-mode coils, Soft x-ray array, Beam emission spectroscopy, Millimeter wave reflectometer, Collective scattering
- Particle Measurements and Diagnostic Neutral Beam
 - Epithermal Neutron detectors, Multichannel Neutron Collimator, Neutron Fluctuation detectors, Diagnostic Neutral Beam
- Charged Fusion Products
 - Escaping Alpha Particle detectors, IR TV (shared with total radiation), Collective Scattering (CO₂?), α -CXRS, Knock-on neutron detectors
- Divertor Diagnostics
 - Divertor IR TV, Visible H α TV, UV Spectrometer, Divertor Bolometer Arrays, Multichord visible spectrometer, Divertor H α monitors, ASDEX-type Neutral Pressure Gauges, Divertor Thomson Scattering, Penning Spectroscopy, Divertor reflectometer
- Plasma Edge and Vacuum Diagnostics
 - Thermocouples, Fixed Edge Probes, Fast Movable Edge Probes, Torus Ion Gauges, Residual Gas Analyzers, Glow Discharge Probes, Vacuum Vessel Illumination

FIRE: Diagnostics Schedule

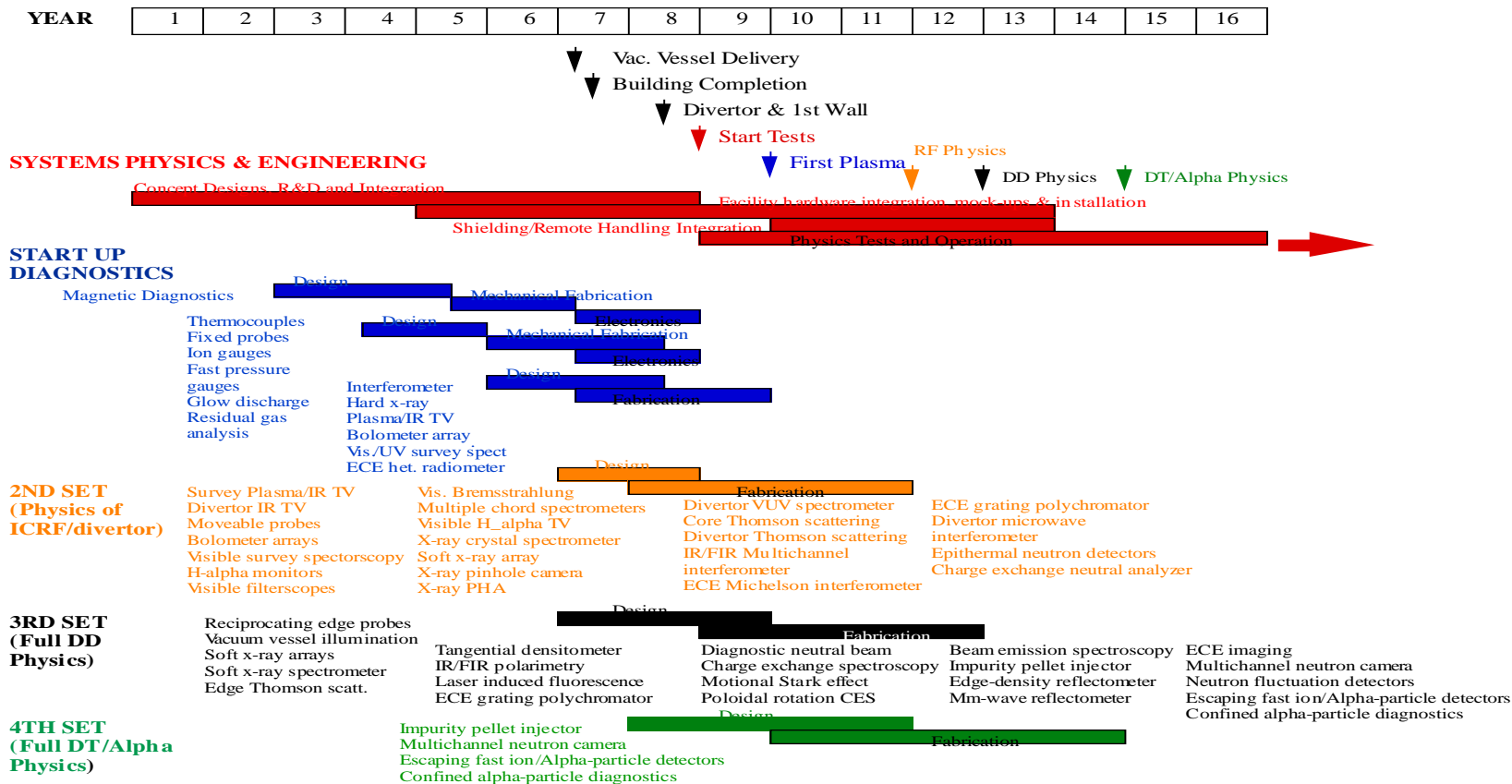

FIRE DIAGNOSTICS SCHEDULE: REVISION 0

1 SEPTEMBER 1999

Edge Physics and PFC Technology: Critical Issue

Plasma Power and particle Handling under relevant conditions
Normal Operation / Off Normal events

Tritium Inventory Control
must maintain low T inventory in the vessel \Rightarrow all metal PFCs

Efficient particle Fueling
pellet injection needed for deep and tritium efficient fueling

Helium Ash Removal
need close coupled He pumping

Non-linear Coupling with Core plasma Performance
nearly every advancement in confinement can be traced to the edge
Edge Pedestal models first introduced in \sim 1992 first step in understanding
Core plasma (low n_{edge}) and divertor (high n_{edge}) requirements conflict

Solutions to these issues would be a major output from a next step experiment.

FIRE is being Designed to Test the Physics and In-Vessel Technologies for ARIES-RS

P_{fusion}
= ~ 150 MW

Volume
= 27 m³

B = 10 T
R = 2.14 m

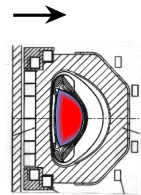

FIRE

~ 3X

B = 8 T
R = 5.5 m

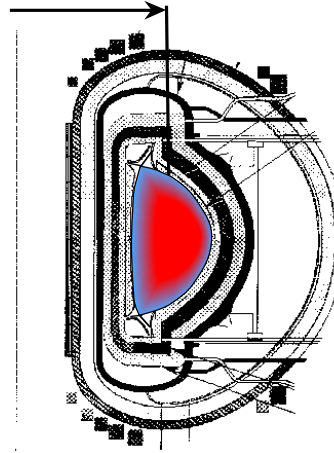

ARIES-RS The "Goal"

P_{fusion}
= 2170 MW

Volume
= 350 m³

	JET	FIRE	ARIES-RS
Fusion Power Density (MW/m³)	0.2	5.5	6
Neutron Wall Loading (MW/m²)	0.2	2.3	4
Divertor Challenge (P_{heat}/NR)	~5	~10	~35
Power Density on Div Plate (MW/m²)	3	~15-19 → 6	~5
Burn Duration (s)	4	20	steady

FIRE's Divertor can Handle Attached (<25 MW/m²) and Detached(5 MW/m²) Operation

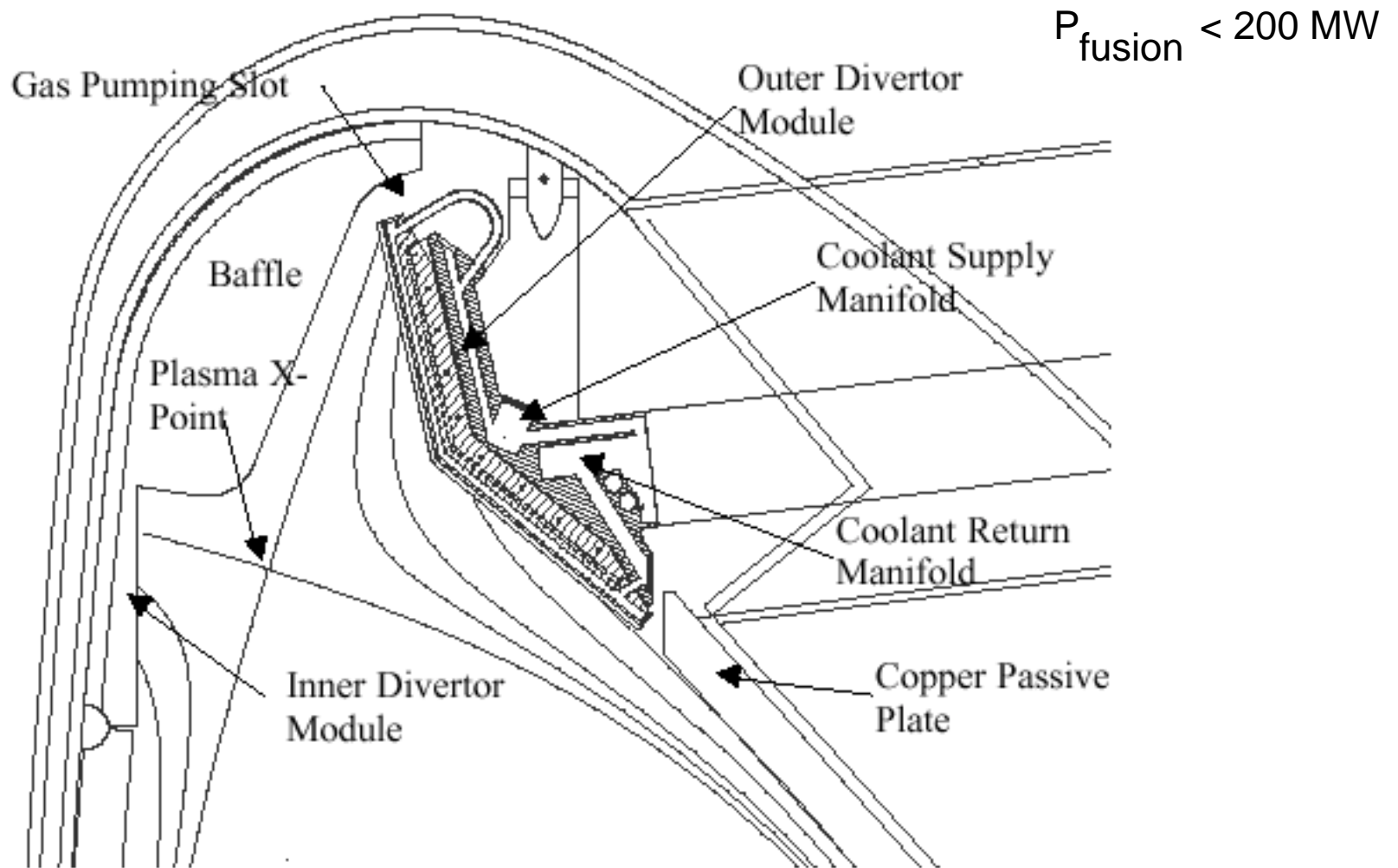

Reference Design is semi-detached operation with <15 MW / m².

Divertor Module Components for FIRE

Sandia

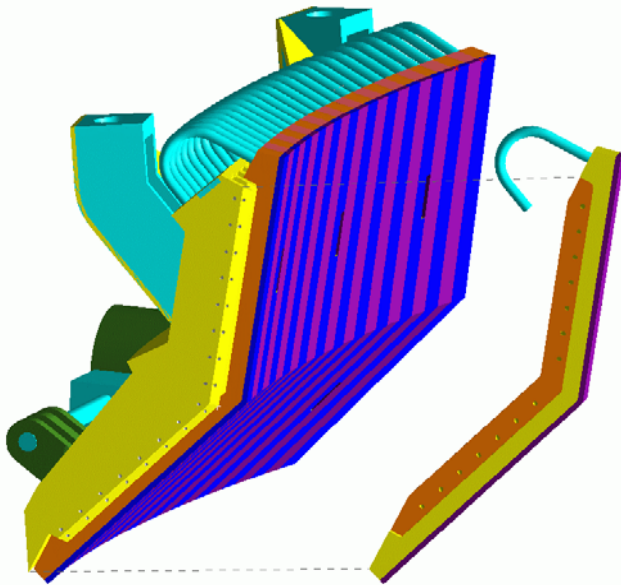

**Finger Plate for
Outer Divertor Module**

**Two W Brush Armor Configurations
Tested at 25 MW/m²**

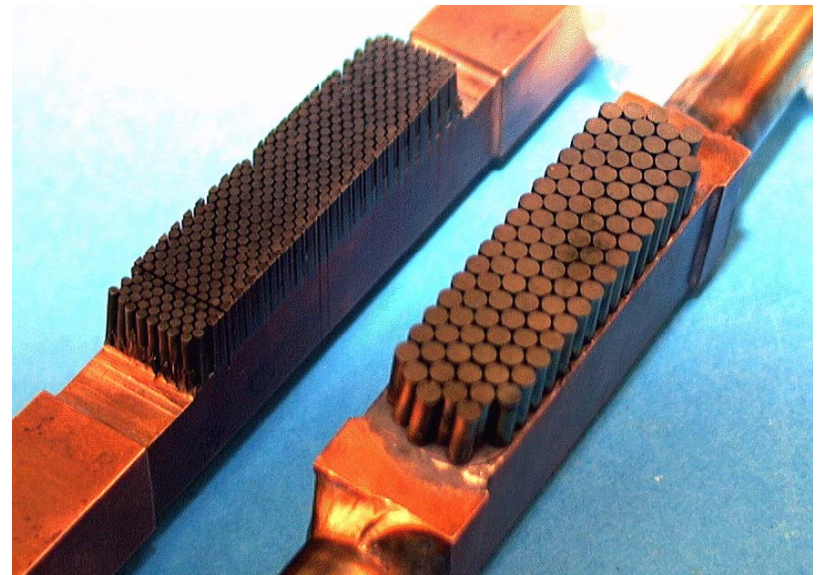

Carbon targets used in most experiments today are not compatible with tritium inventory requirements of fusion reactors.

Combined stresses, 20 s pulse

- Nuclear heating, gravity, coolant pressure, vacuum

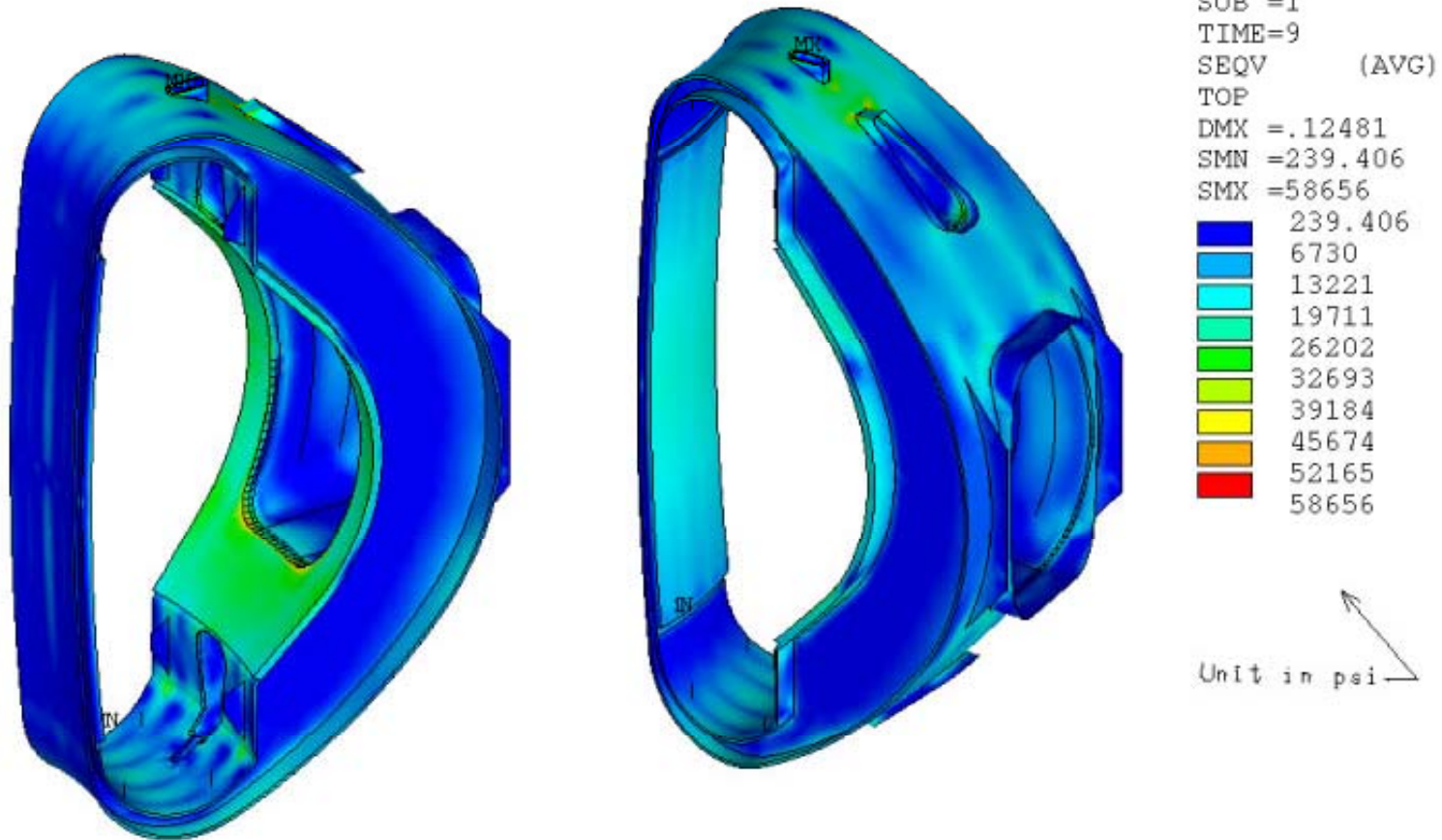

FIRE In-Vessel Remote Handling System

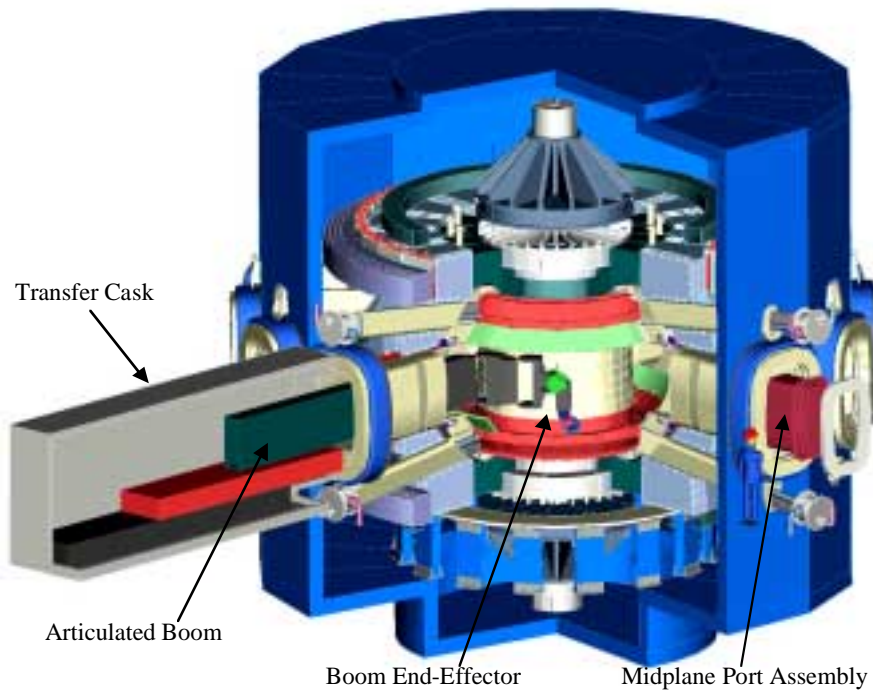

In-vessel transporter

- Articulated boom deployed from sealed cask
- Complete in-vessel coverage from 4 midplane ports
- Fitted with different end-effector depending on component to be handled
- First wall module end-effector shown

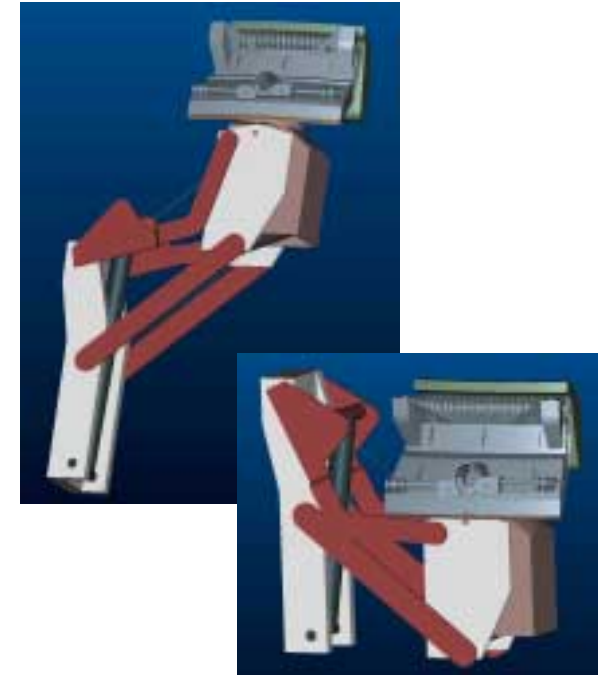

Divertor end-effector

- High capacity (module wt. ~ 800 kg)
- Four positioning degrees of freedom
- Positioning accuracy of millimeters required

Advanced Tokamak Program Leading to an Attractive MFE Reactor

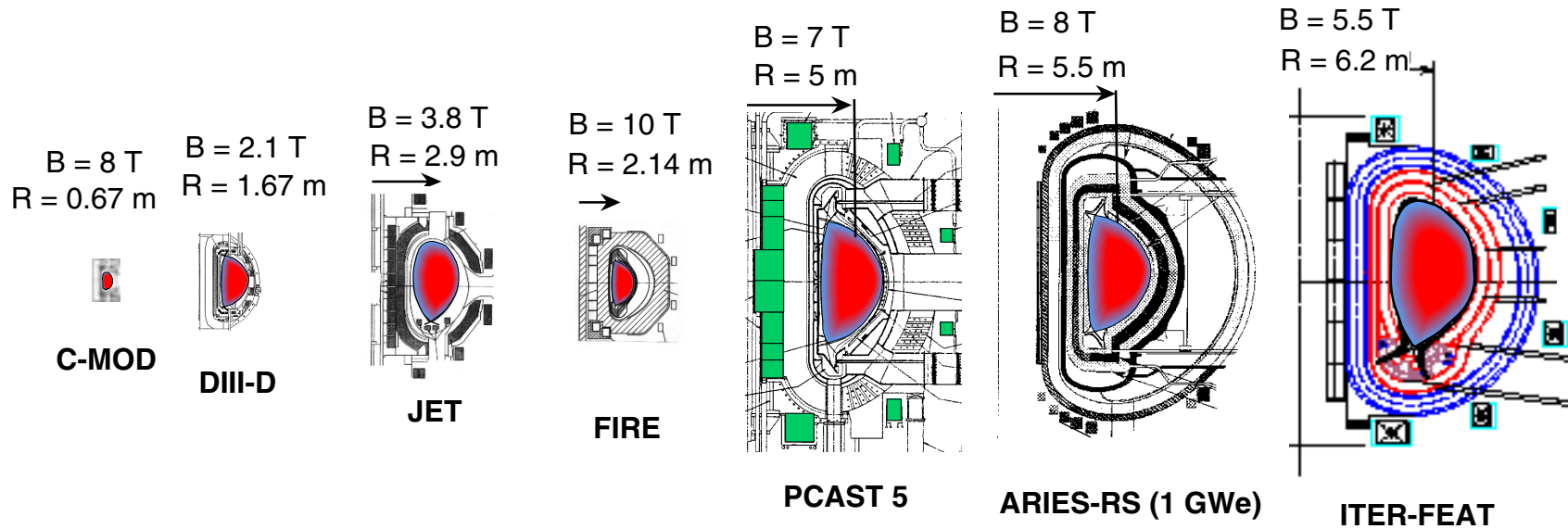

Cost Drivers	C-MOD	DIII-D	JET	FIRE	PCAST	ARIES-RS	ITER-FEAT
Plasma Volume (m^3)	1	18	95	27	390	350	828
Plasma Surface (m^2)	2	30	180	60	420	390	610
Plasma Current (MA)	2	2	4	7.7	15	11.3	15
Magnet Energy (GJ)			1.6	5	40	85	50
Fusion Power (MW)			16	150	400	2170	400
Burn Duration (s), inductive		1	1	20	120	steady	400
$\tau_{\text{Burn}} / \tau_{\text{CR}}$	5	1	≤ 1	2	1	steady	2
Cost Estimate (\$B-2000\$)			~0.9	1.2	6.7	10.6/2	4.6

Recommended US Plan for Burning Plasmas

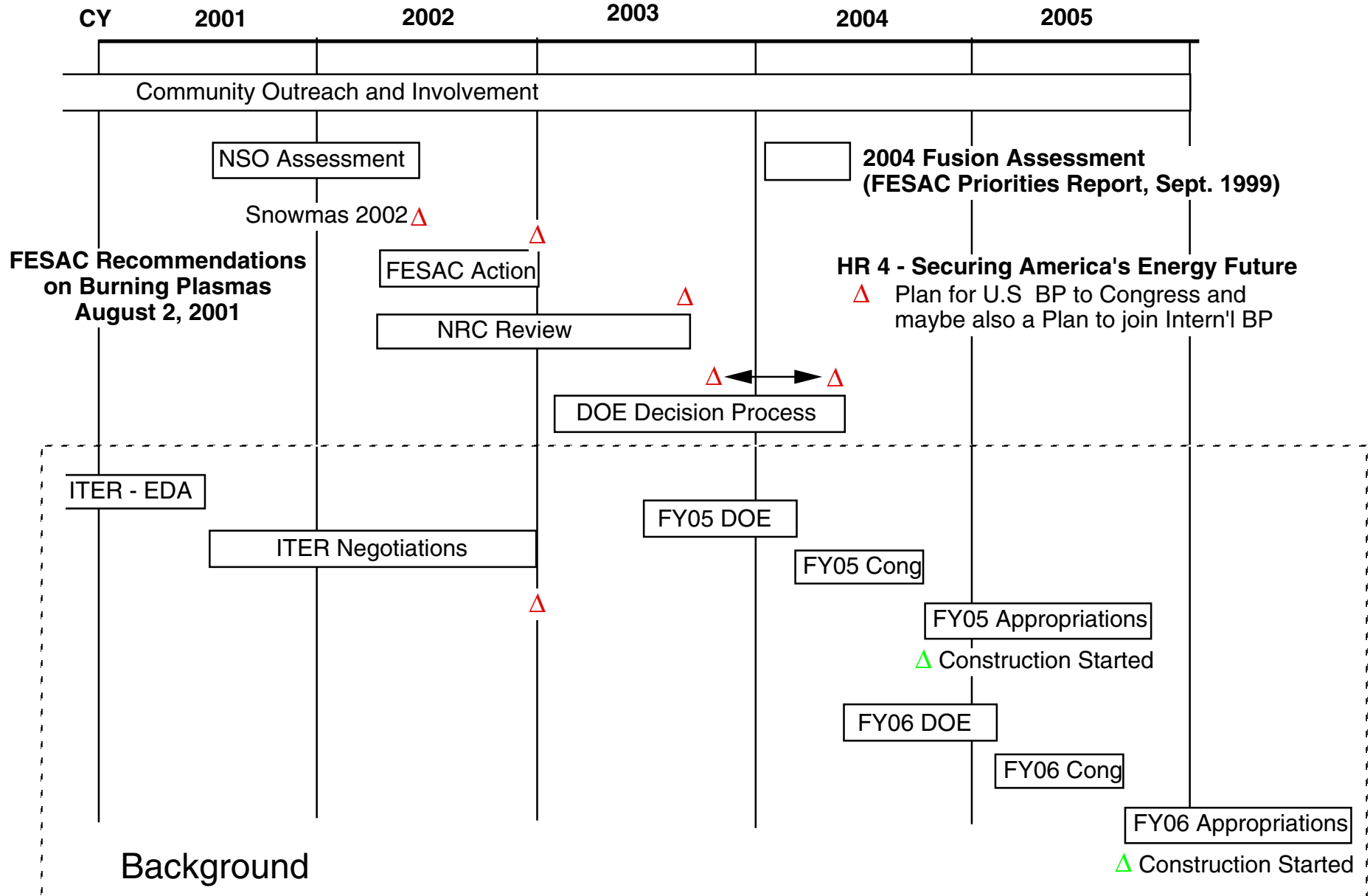

Illustrative Schedule for U.S. Burning Plasma Experiment

FY

2000	2001	2002	2003	2004	2005	2006	2007	2008	2009	2010
------	------	------	------	------	------	------	------	------	------	------

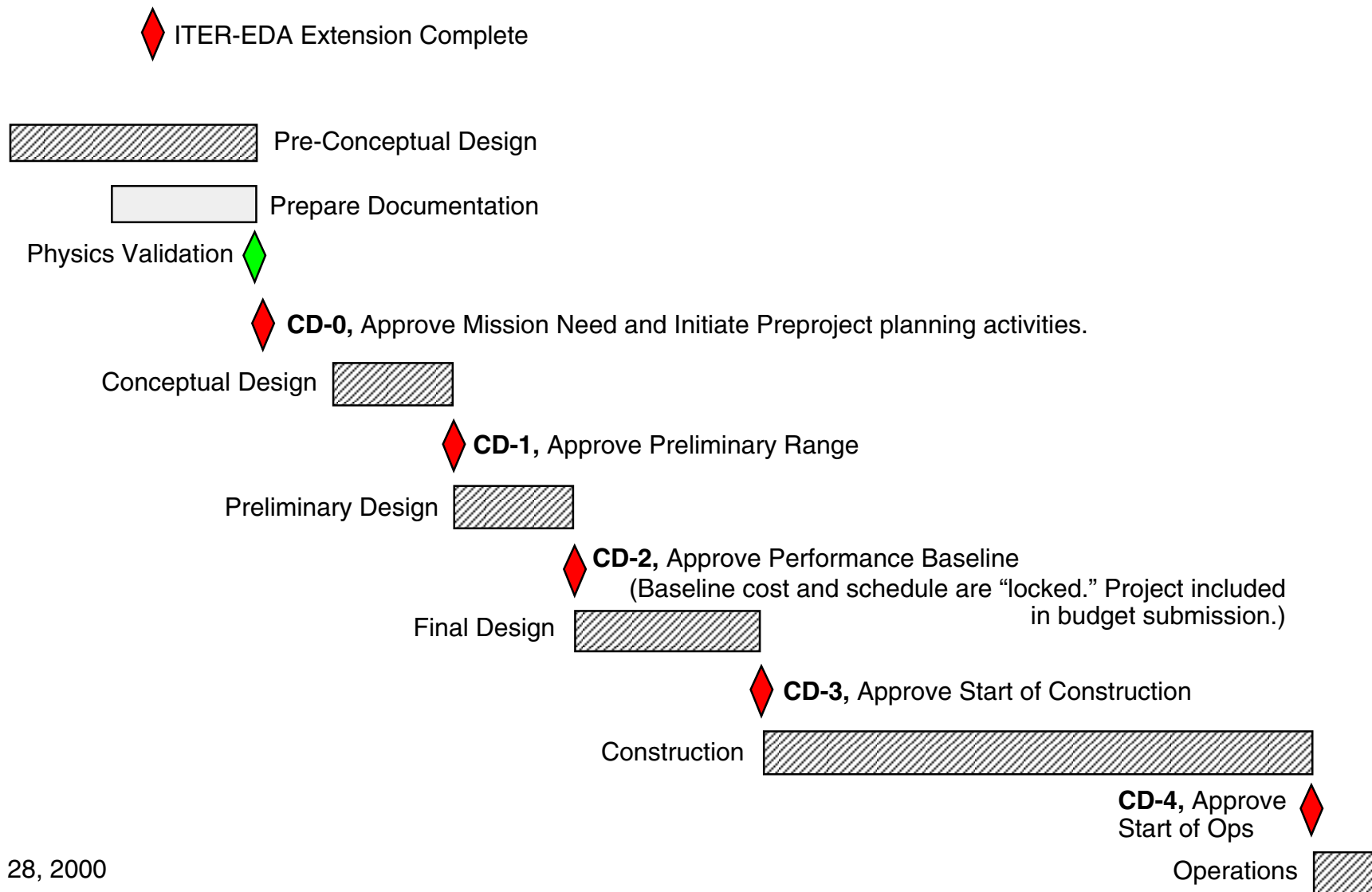

Jan 28, 2000

Timetable for “Burn to Learn” Phase of Fusion

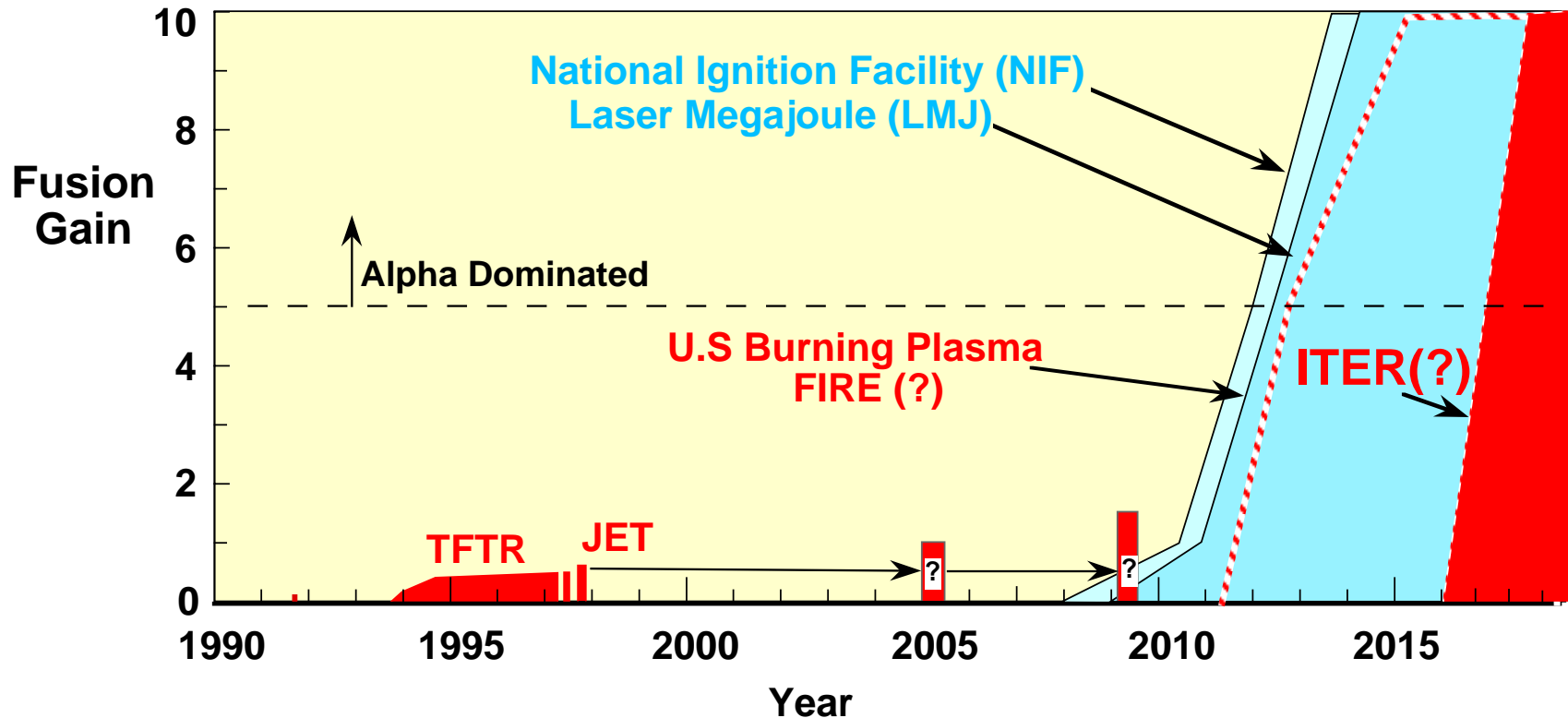

- Even with ITER, the MFE program will be unable to address the alpha-dominated burning plasma issues for ≥ 15 years.
- Compact High-Field Tokamak Burning Plasma Experiment(s) would be a natural extension of the ongoing “advanced” tokamak program and could begin alpha-dominated experiments by ~ 10 years.
- **More than one high gain burning plasma facility is needed in the world program.**
- The Snowmass 2002 Summer Study will provide a forum to assessing approaches. The NRC Review in 2002 will assess contributions to broader science issues..

Summary

- A Window of Opportunity may be opening for U.S. Energy R&D. We should be ready. The Modular or Multi-Machine Strategy has advantages for addressing the science and technology issues of fusion.
- A compact high field tokamak, like FIRE, has the potential:
 - address the important burning plasma issues,
 - most of the advanced tokamak issues and,
 - begin to study the strong non-linear coupling between BP and AT under quasi-stationary conditions in a \$1B class facility.
- Some areas that need additional work to realize this potential include:
 - Apply recent enhanced confinement and advanced modes to FIRE
 - Understand conditions for enhanced confinement regimes
 - Compare DN relative to SN - confinement, stability, divertor, etc
 - Complete disruption analysis, develop better disruption control/mitigation.
 - Respond to FIRE Engineering Review and NSO PAC on specific physics R&D and engineering design and R&D issues.

<http://fire.pppl.gov>

**Laboratories are Needed to Explore, Explain
and Expand the Frontiers of Science**



CHANDRA

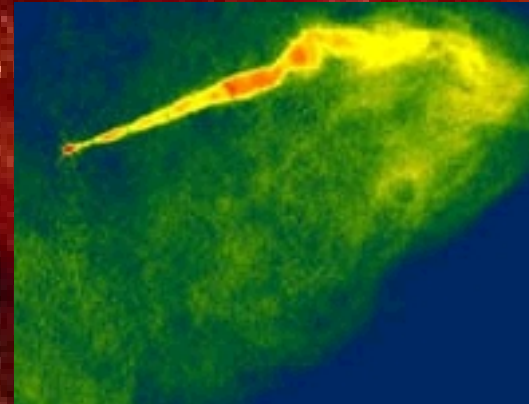

VLBA



NIF



NSO



HST (NGST)

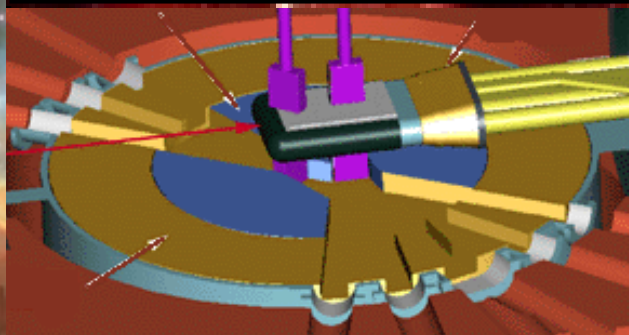

SNS

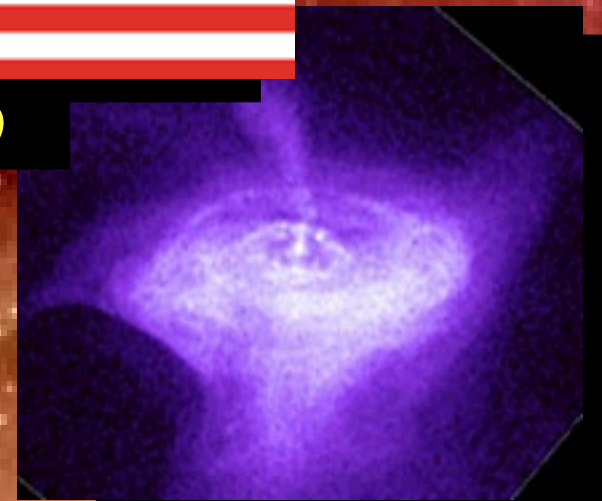

CHANDRA